

Automotive Lamp Catalogue
Catalogue Lampes Auto
Lichtprogramm Fahrzeuglampen
Catalogo Lampade Automotive
Catálogo Lámparas de Automoción





GE Consumer & Industrial provides a broad range of products and services throughout the world, including appliances, lighting and electrical distribution solutions.

Providing solutions for commercial, industrial and residential use in more than 100 countries, GE Consumer & Industrial uses innovative technologies and "Ecoimagination", a GE initiative to aggressively bring to market new technologies that help customers and consumers meet pressing environmental challenges.

GE Lighting - a division of GE Consumer & Industrial - is one of the largest suppliers of light sources in the world. We provide state-of-the-art technology and are able to offer a full range of incandescent lamps, Fluorescent lighting products, Halogen, HID, Compact fluorescent and Automotive lamps.

GE has played a leading role in Automotive Lighting for many years. Nowadays we are able to offer a full range of vehicle lamps operating on either 12V or 24V systems. The automotive product range produced in Europe - which is included in this catalogue - is sold all over the world, both for original equipment use and for use in the aftermarket. Upon request a separate catalogue is available on the GE Lighting North American Automotive range.



GE Consumer et Industrial fournit une gamme très large de produits et de services dans le monde, comme des appareils électroménagers, des produits et des solutions pour l'éclairage et la distribution de courant électrique.

Ces produits et solutions sont vendus dans plus de 100 pays pour les marchés du secteur secondaire et tertiaire, ainsi que pour celui de la consommation en utilisant des process innovants.

"Ecoimagination" est une initiative de GE pour apporter des nouvelles technologies sur le marché d'une façon dynamique pour aider ses clients et les consommateurs à gagner face aux défis environnementaux. GE Lighting - une des divisions de GE Consumer et Industrial - est un des plus importants fabricants de sources d'éclairage dans le monde fournissant des produits les plus modernes dans une gamme très large des lampes à incandescence, les tubes fluo, des lampes halogène et fluo-compactes, les lampes à décharge et les lampes auto.

GE a joué un rôle important dans le domaine de l'éclairage automobile dès le début et offre une gamme très large en 12V et 24V. Ces sont les lampes destinées à l'Europe qui sont présentées dans ce catalogue mais vous pouvez avoir - sur demande - un catalogue spécial pour les lampes du marché nord-américain. Les lampes figurant dans ces catalogues sont vendues mondialement aussi bien pour la première monte que pour le marché de la rechange.



GE Consumer & Industrial bietet Ihnen eine weltweit breite Palette von Produkten und Dienstleistungen für Haushaltsgeräte, Beleuchtung und elektrische Verteilersysteme an. GE Consumer & Industrial bietet Lösungen für Gewerbe, Industrie und private Haushalte in mehr als 100 Ländern. GE Consumer & Industrial bietet innovative Technologie und "Ecoimagination", eine Initiative von GE, um mit neuen Technologien die Herausforderungen für eine saubere Umwelt zu meistern.

GE Lighting - ein Teil von GE Consumer & Industrial - ist einer der größten Hersteller von Lichtquellen mit modernster Technologie und bietet das gesamte Spektrum an Glüh-, Halogen-, Leuchtstoff-, Kompaktleuchtstoff- und Gasentladungslampen einschließlich Automobilbeleuchtung.

GE hatte von Anfang an eine führende Rolle in der Automobilbeleuchtung und bietet heute ein breites Spektrum im 12V und 24V Segment, sowohl für die Erstausrüstung als auch für den Aftermarket. Die Produktpalette für Automobilbeleuchtung in diesem Katalog wird überwiegend in Europa hergestellt. Auf Anfrage senden wir gerne einen Katalog von GE Lighting Nord Amerika für die Automobilbeleuchtung.



GE Consumer & Industrial ofrece una amplia gama de productos y servicios en todo el mundo, incluyendo electrodomésticos, iluminación y distribución de soluciones para electricidad. A la vez también proporciona soluciones para empresas comerciales, industriales así como de hogar en más de 100 países.

GE Consumer & Industrial utiliza tecnologías innovadoras, y entre ellas está "Ecoimagination", una iniciativa de GE que pretende introducir en el mercado nuevas tecnologías que puedan ayudar a los clientes y consumidores a realizar cambios importantes y de mejora en el medio ambiente.

GE Lighting - una de las divisiones de GE Consumer & Industrial - es uno de los más importantes proveedores de fuentes de luz en el mundo con la tecnología más avanzada, ofreciendo una gama completa de lámparas incandescentes, así como productos de iluminación fluorescente, halógenas, HID, fluorescencia compacta y lámparas de automoción.

GE ha desempeñado desde su inicio un papel de liderazgo en la iluminación del automóvil. Actualmente estamos ofreciendo una gama completa de lámparas para automoción en 12V y 24V. La gama de productos para automoción que fabricamos - y que se incluye en el presente catálogo - se vende en todo el mundo tanto para uso en equipo original (primer equipo OEM) así como para el mercado del recambio (AM). También disponemos de un catálogo, que bajo solicitud, podrá comprobar nuestra gama de disponibilidad en lámparas de automoción GE Lighting para el mercado de Norte América.



GE Consumer & Industrial fornisce una vasta gamma di prodotti e servizi in tutto il mondo, compresi gli elettrodomestici, e soluzioni per l'illuminazione e la distribuzione dell'energia elettrica. Fornisce soluzioni per l'uso in attività commerciali, industriali e residenziali, in più di 100 paesi; GE Consumer & Industrial utilizza tecnologie innovative ed "Ecoimagination", una aggressiva iniziativa di GE per portare sul mercato nuove tecnologie che aiutino i clienti ed i consumatori a soddisfare le nuove sfide a tutela dell'ambiente.

GE Lighting - una divisione di GE Consumer & Industrial - è uno dei maggiori fornitori di sorgenti luminose nel mondo, grazie ad una elevata tecnologia, offre una gamma completa di lampade ad incandescenza, lampade fluorescenti, Alogene, HID, fluorescenti compatte e lampade Auto.

GE che da sempre svolge un ruolo importante nel mercato "lighting automotive", oggi offre una gamma completa di lampade per auto in 12V e 24V. La gamma di prodotti, fabbricati in Europa, inclusa nel presente catalogo - è venduta in tutto il mondo, sia per il mercato del primo equipaggiamento (OEM) che per il mercato del ricambio. Su richiesta, è disponibile anche un catalogo di lampade auto GE per il mercato nord-americano.

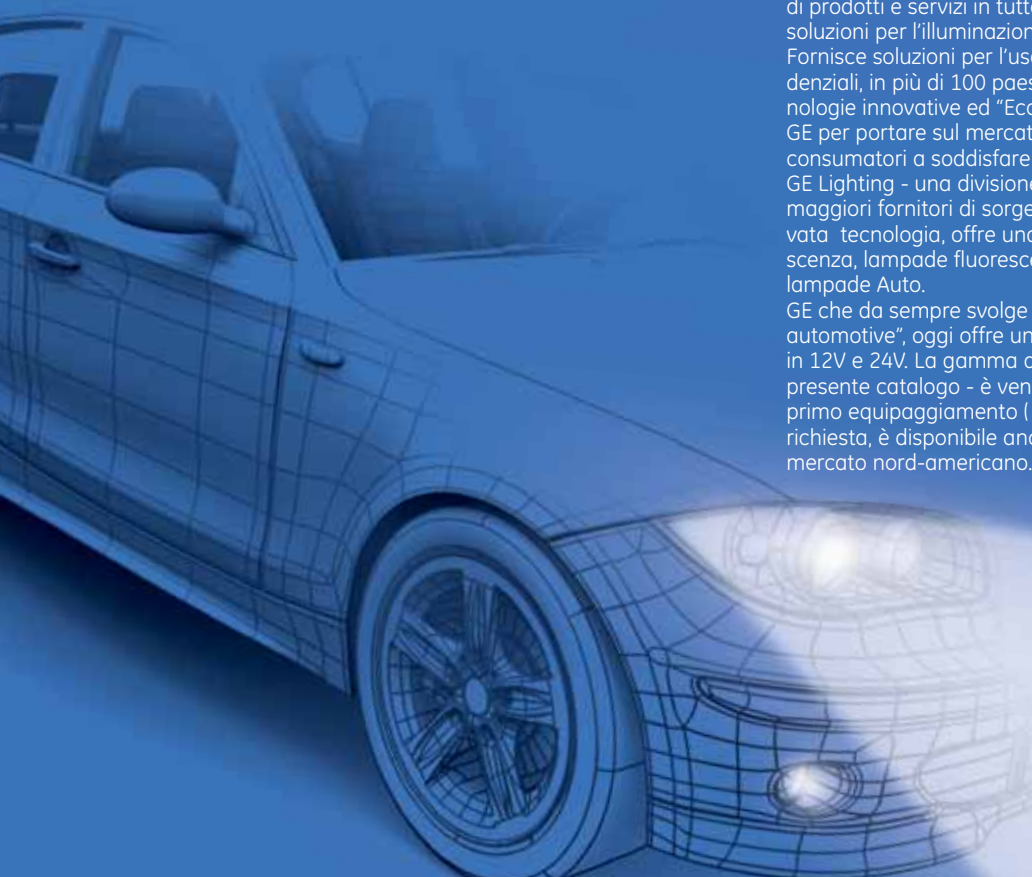

Certification



The company is on the Approval list of many of the worlds car manufacturers, where quality and performance are key measurements. The reliability and quality of automotive lamps is ensured by:

- Computer-managed and controlled design process
- Fully automated production lines
- High level of quality assurance system
- Continued investment programs
- A commitment to continuous improvement



Nos lampes figurent dans les références en homologation de beaucoup de constructeurs dans le monde qui est une reconnaissance de leur qualité et de leur performance. La fiabilité et la qualité sont assurées

- par un procédé de fabrication assisté et contrôlé par ordinateur
- par des lignes de fabrication automatiques
- et par un système de qualité de haut niveau



Unser Unternehmen befindet sich auf den meisten Freigabelisten der weltweiten Automobilindustrie, dort wird der Schwerpunkt auf Qualität und Leistungsfähigkeit gesetzt. Die verlässliche Qualität der Automobil Lampen wird erreicht durch

- computergestützte 100% Qualitätskontrolle
- vollautomatische Produktionsverfahren
- hochentwickelte Qualitätssicherungssysteme



Nuestra compañía está Homologada en la mayoría de fabricantes de automóviles en el ámbito mundial, lo que significa que las medidas de calidad son claves. La fiabilidad en la calidad de nuestras lámparas de automoción está garantizada por:

- Control total del diseño de proceso por ordenador.
- Líneas de producción totalmente automáticas.
- Los más estrictos controles de calidad.



L'azienda ed i suoi prodotti sono omologati dai principali costruttori di automobili di tutto il mondo per i quali la qualità e le prestazioni sono parametri fondamentali. L'affidabilità e qualità delle nostre lampade auto sono garantite da:

- Controllo egstione computerizzata totale del processo di sviluppo del prodotto
- linee di produzione completamente automatizzate
- elevato livello di sistema di garanzia della qualità.



ISO 9001, ISO TS 16949 and ISO 14001 quality system certification



ECE compliance, homologation



Global OEM customer base

EoLV, ROHS compliance



Use of UV cut glass, safe for use in plastic headlights

Contents

Introduction, Certification, Contents, Automotive Lamps Introduction - Einführung - Introducción - Introduzione	2-5
"XENSATION™" - D1S, D2S, D2R headlight lamps 12V Lampes principales D1S, D2S, D2R - 12V SAE-Hauptscheinwerferlampen D1S, D2S, D2R - 12V Lámparas de fero D1S, D2S, D2R - 12V Lampade per proiettori, D1S, D2S, D2R "XENSATION™"	6-7
12V halogen headlight lamps - "PREMIUM" 12V Lampes principales halogene - Halogen Scheinwerferlampen - Lámparas de fero halógenas - Lampade per proiettori alogene "PREMIUM"	8-9
MEGALIGHT ULTRA	10-11
MEGALIGHT PLUS	12-13
SPORTLIGHT - incl. miniature lamps	14-15
EXTRA LIFE - incl. miniature lamps	16-17
RALLY - OFF ROAD	18-19
12V Headlight lamps - R2, H4 - upper and lower beam, H1, H2, H3, H7, H8, H9, H10, H11, HB3, HB4 - single filament lamps 12V Lampes principales H4, R2, Lampes monofilament H1, H2, H3, H7, H8, H9, H10, H11, HB3, HB4 - 12V Zweifaden-Hauptscheinwerferlampen H4, R2, Einfadenlampen H1, H2, H3, H7, H8, H9, H10, H11, HB3, HB4 - 12V Lámparas de fero H4, R2 de doble filamento, Lámparas de un filamento H1, H2, H3, H7, H8, H9, H10, H11, HB3, HB4 - 12V Lampade per proiettori H4, R2, Lampade ad un filamento H1, H2, H3, H7, H8, H9, H10, H11, HB3, HB4	20-21
Miniature lamps - "PREMIUM" Lampes miniatures - Miniaturlampen - Lámparas miniatura - lampade miniature "PREMIUM"	22-23
12V Tail, stop and direction lamps 12V Feu rouge/Stop/Clignotant - 12V Blink-, Brems- und Schlußlichtlampen - 12V Lámparas traseras, freno e intermitente 12V Lampade per fanali posteriori, luci di arresto e direzione	24
12V Interior lamps, miniature halogen lamps 12V Lampes éclairage intérieur, lampes miniatures halogene - 12V Lampen für Innenbeleuchtung, miniatur-halogenlampen - 12V Lámparas de interior, lámparas halógenas miniatura - 12V Lampade per illuminazione interna, lampade miniature alogene	25
12V Tail, direction, parking and indicator lamps 12V Feu rouge/clignotant/Feu de position/Répetiteur latéral - 12V Blink-, Brems- und Schlußlichtlampen - 12V Lámparas traseras, marcha atrás e indicadoras - 12V Lampade per fanali posteriori, luci di arresto e direzione	26
12V Wedge base lamps with plastic cap 12V Lampes "wedge base" avec culot plastique - 12V Glassockellampen mit Steckfassung - 12V Lámparas con base de plástico - 12V Lampade con attacco in plastica	27
Heavy Duty Long Life - 24V Truck lamps with longer life and increased robustness Les lampes 24V pour les poids lourds avec une durée de vie allongée et une résistance accrue - Lampade per Camion : 24V, durata di vita e robustezza superiori alle lampade standard - Lámparas de camión de 24V, con una duración de vida más larga y una mayor solidez - 24V Lampen für LKW und Busse mit längerer Lebensdauer und höherer Robustheit	28-29
24V Double and single filament headlight lamps 24V Lampes principales - 24V Zwei- und Einfaden Hauptscheinwerferlampen - 24V Lámparas de fero de uno y doble filamento - 24V Lampade mono e bifilamento per proiettori	30
24V Tail, direction, parking and indicator lamps 24V Feu rouge/clignotant/Feu de position/Répetiteur latéral - 24V Blink-, Brems- und Schlußlichtlampen - 24V Lámparas traseras, marcha atrás e indicadoras - 24V Lampade per fanali posteriori, luci di arresto e direzione	31
24V Interior lamps 24V Lampes éclairage intérieur - 24V Lampen für Innenbeleuchtung - 24V Lámparas de interior - 24V Lampade per illuminazione interna	32
24V Tail, stop and direction lamps 24V Feu rouge/Stop/Clignotant - 24V Blink-, Brems- und Schlußlichtlampen - 24V Lámparas traseras, freno e intermitente - 24V Lampade per fanali posteriori, luci di arresto e direzione	33
Emergency kits, displays 12V-24V coffrets de secours - 12V-24V Autolampen-Ersatzkästen - 12V-24V Estuches de repuesto - 12V-24V Scatola lampade di scorta	34-35
Packaging, blisters Emballage - Verpackungen - Embalaje - Imballo	36-39
Symbols, marking	40-41
Lamp bases Culot - Sockelübersicht - Casquillos de lámparas - Attacchi lampade	42
GE Lighting contacts	43

Legend

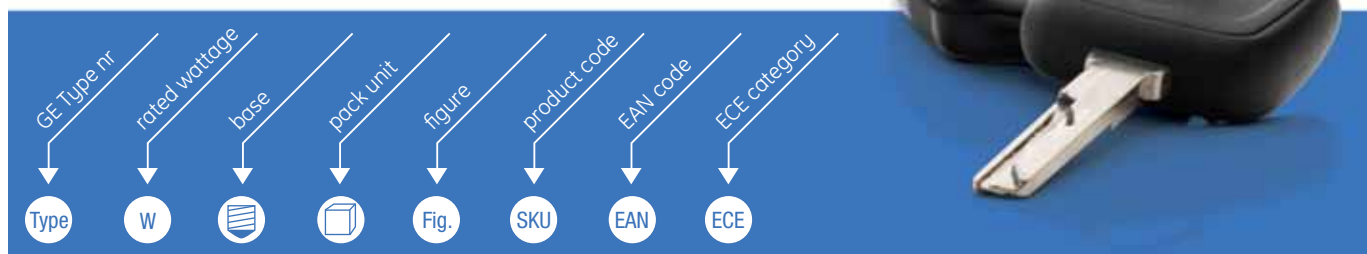

Automotive Lamps

front light

D1S D2S D2R H1 H3 H4 H7 H9 H11 HB3 HB4 R2

side turn signals

W5W WY5W T4W

parking light

T4W W5W H6W

fog light

H1 H3 H7 H8 H10 H11

side signals, warning lights

P21W PY21W W21W WY21W

dashboard and interior light

W5W W3W 1.2W T4W C5W fest 10W H6W

parking lights

R5W R10W P21/5W P21/4W W21/5W

stop light (CHMSL)

W5W W16W

license plate

R5W C5W W5W T4W

side signals, warning lights

P21W PY21W W21W WY21W

trunk light

R5W C5W 10W

stop lights

P21W P21/5W P21/4W W21/5W W21W

fog lights

P21W W21W

reverse light

P21W W16W W21W

Xenon High Intensity Discharge lamps

Xensation™ - D1S, D2S, D2R

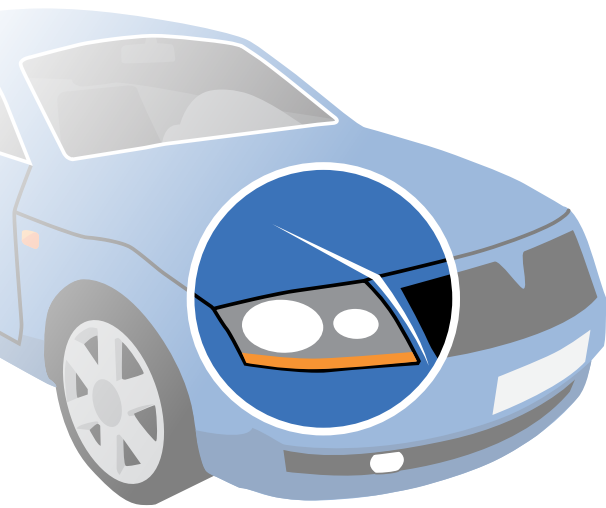

- high beam
- low beam

GE Innovation
+ experience
Top performance

Xensation GE D1S, D2S, D2R - Automotive discharge headlight lamps

Thanks to our latest lighting technology, GE Xensation lamps provide a major leap in road safety over conventional halogen lamps due to enormous increase in the illuminated field of vision. See the comparative light charts and photos below.

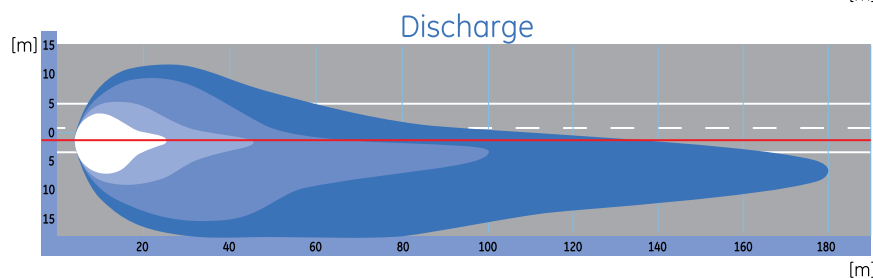
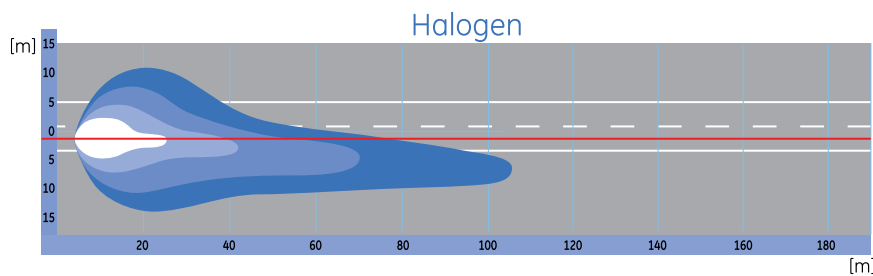

Benefits of GE Discharge lamps:

- Better visibility and illumination- the light emitted provides the driver with many benefits. It assists the human eye and allows better visibility and improved hazard awareness, allowing the driver to navigate poor driving conditions with increased confidence and with less fatigue.
- Greater illuminated area on the road.
- Lower power consumption – 35W only instead of 55W (ordinary halogen lamp power consumption).
- Better durability – excellent vibration and shock resistance giving significantly greater reliability.
- Optically advantageous whiter light compared to halogen lamps designed to give a colour that is closer to natural daylight.

Type	Colour Temperature (K)	
	D2S	D2R
Blue Standard 53500, 53510	4100	4000
Blue* 53550, 53570	5100, 6000	5100, 6000
Super Blue* 53560, 53580	10 000	10 000

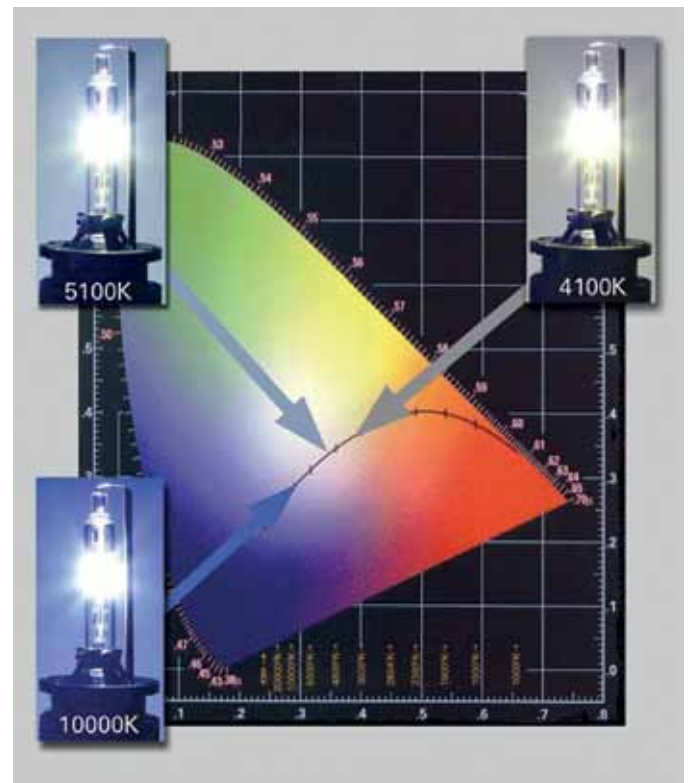

D1, D2

	Type	ECE	W			Fig.	SKU	EAN
XENON-HID – Headlight lamps								
D2S	53500	D2S	35	P32D-2	1/8/32	1	93036	0043168930369
	53500	D2S	35	P32D-2	1/3/12	1	20077	0043168930369
	53550 - 5100K		35	P32D-2	1/8/32	1	20043	0043168200431
	53560 - 10000K		35	P32D-2	1/8/32	1	20045	0043168200455
D2R	53510	D2R	35	P32D-3	1/8/32	2	93218	0043168932189
	53510	D2R	35	P32D-3	1/3/12	2	20079	0043168932189
	53570 - 5100K		35	P32D-3	1/8/32	2	20044	0043168200448
	53580 - 10000K		35	P32D-3	1/8/32	2	20046	0043168200462
D1S	53620	D1S	35	PK32D-2	1/4/12	3	78129	0043168781299

* 5100K, 6000K and 10000K high colour temperature Blue and Super Blue discharge lamps have no E-mark, designed for OFF ROAD use only.

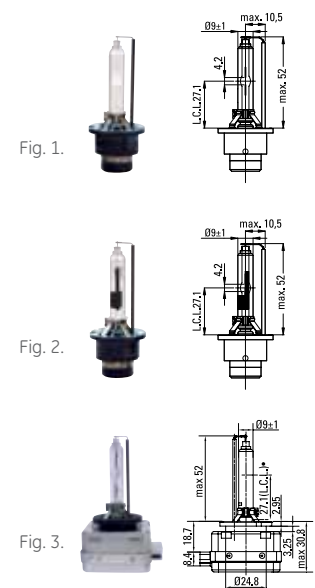

Halogen headlight lamps

lighting your way...

As well as the basic range, GE automotive also offers the premium range, based on special lamp designs. The premium range includes: Extra Life, Megalight Plus, Megalight Ultra, Rally, Sportlight. The premium lamps have additional benefits in terms of life, colour, vibration resistance or wattage.

The premium lamps are also E1 marked, making their use on the EU roads possible, with the exception of Rally lamps that were designed for off-road usage.

Extra life lamps have enhanced life, Megalight Plus and Ultra lamps possess increased luminance, Sportlight halogen lamps give intense blue-white light.

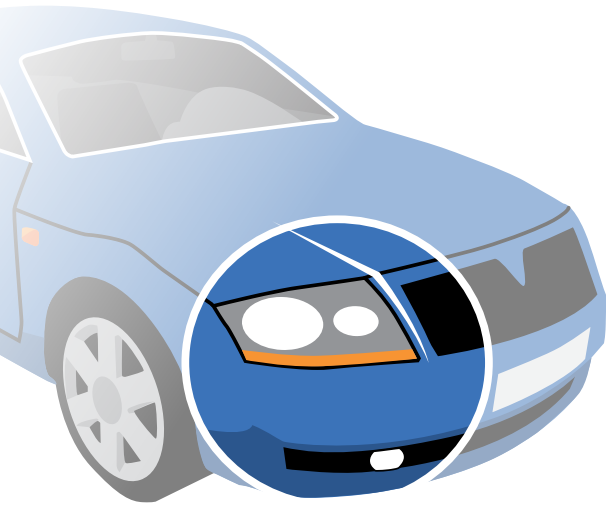

Colour temperature-luminance-life comparisons for the premium range.

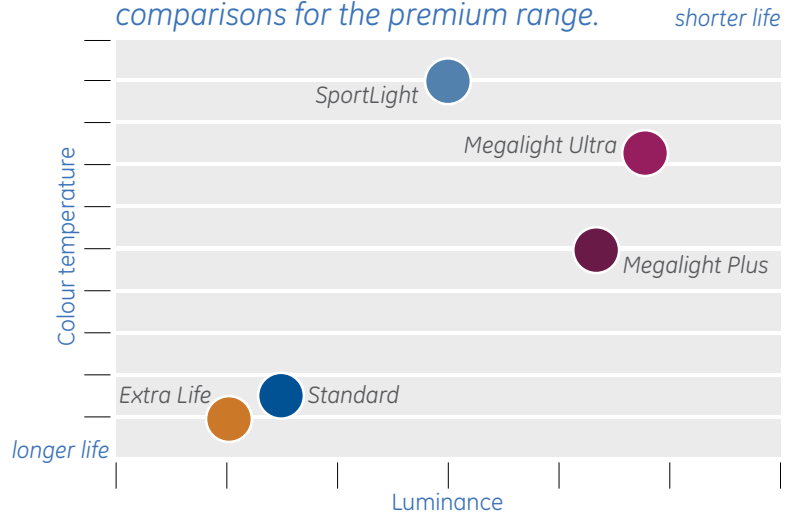

UPGRADE
your car with
GE premium lamps

H1



H3



H4



H7



Megalight Ultra
up to **90%** more light



Megalight Plus
50-60% more light



SportLight
when you really want to **see and be seen**



Extra Life
better economy for daytime lighting



Rally
for **off-road** use only



GE "Reliable" range
quality- performance
fully replacable with OEM lamps



Operational voltage is a critical parameter influencing the life time of the automotive lamps. The life of the lamp is sensitive to the operation voltage of the car, 1% of change of the voltage results in 12-15% change of life with opposite sign.

More light

- Better visibility
- Improved driving performance

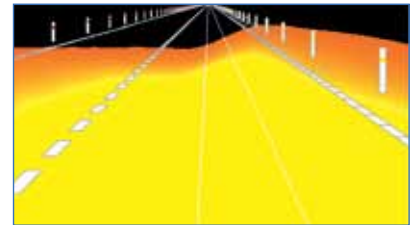
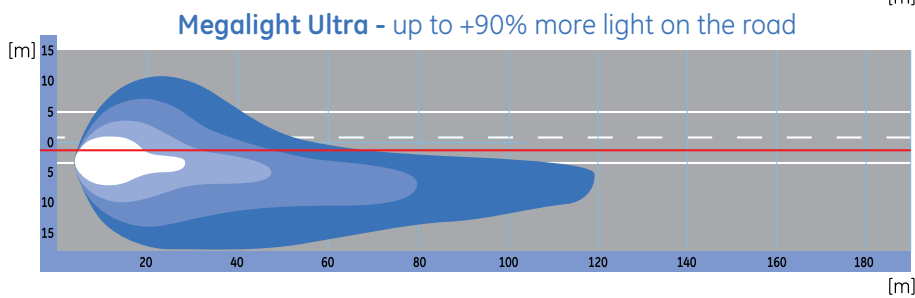
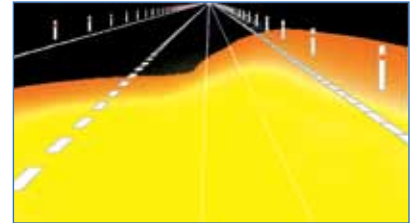
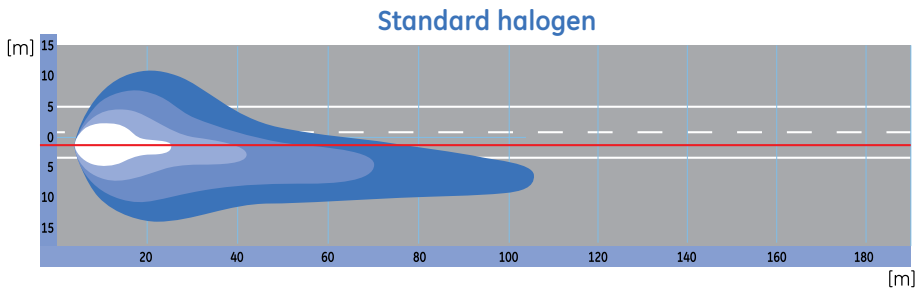

H8	H9	H10	H11	HB3	HB4
			●	●	●
				●	●
				●	●
●	●	●	●	●	●



The special quartz glass used for GE automotive lamps cuts the UV component of light, it means that GE automotive lamps can safely be used in plastic reflectors without the risk of discoloration.

Megalight Ultra



Up to 90% more light on the road

High performance lamps for visibility, convenience and style

- Improved driving performance at night
- Most intense and powerful lamp, in terms of luminance, for safer driving



Jusqu'à 90% plus de lumière sur la route

Lampes à haute performance pour le confort visuel et style

- Meilleure performance de conduite dans la nuit
- La lampe la plus intense en termes de luminance pour une conduite plus sécurisée



Fino al 90% di luce in più sulla strada:

lampade ad alta prestazione in termini di visibilità, convenienza e stile

- Migliori prestazioni di guida durante la notte
- Lampada più intensa e più potente, in termini di luminosità, per una guida più sicura



Hasta un 90% más de luz en carretera

Alto rendimiento. Lámparas que aúnan visibilidad, comodidad y estilo

- Para una mejor conducción nocturna
- La lámpara más intensa y potente en cuanto a intensidad lumínica, para una conducción más segura



Bis zu 90% mehr Licht auf der Straße

Verbessern Sie Ihr Fahrverhalten durch stressfreies Sehen, dank des helleren Lichtes

- Verbesserte Sicht bei Nacht
- Die intensivste und leistungsstärkste Lampe in bezug auf Helligkeit und Fahrsicherheit



Street
Legal

12V

Type

ECE

W



Fig.

SKU

EAN

Megalight Ultra - Headlight lamps

Headlight lamps - upper and lower beam

Lampes principales

Hauptscheinwerferlampen

Lámparas de faro - doble filamento

Lampade per proiettori - abbagliante ed anabbagliante

50440SXU	H4	60/55	P43t	2/12/48 display	1	73500	0043168735001
				2/20 blister	1	74153	0043168741538
58520SXU	H7	55	PX26d	2/16/64 display	2	96923	0043168969239
				2/20 blister	2	74154	0043168741545
50310XU	H1	55	P14,5s	2/16/64 display	3	96946	0043168969468
				2/20 blister	3	96948	0043168969482
53060XU	HB3	60	P20d	2/12/48	4	79295	0043168792950
53070SXU	HB4	51	P22d	2/12/48	5	79296	0043168792967
53110SXU	H11	55	PGJ19-2	2/12/48	6	79297	0043168792974



Fig. 1.

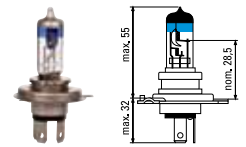

Fig. 2.

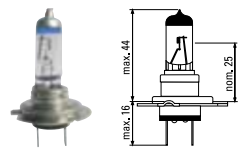

Fig. 3.

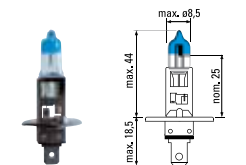

Fig. 4.

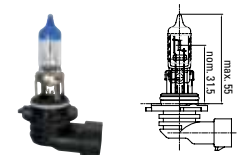

Fig. 5.

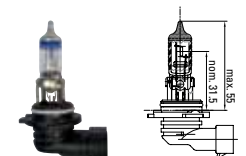
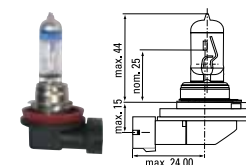

Fig. 6.



Megalight Plus



Up to 50-60% more light on the road

- Special high luminance lamp design
- Longer beam
- Brighter illumination



Jusqu'à 50 à 60% plus de lumière sur la route

- Une conception pour une luminance plus élevée
- Un faisceau plus long
- Une illumination plus brillante



Fino al 50-60% di luce in più sulla strada

- Speciale design della lampada ad alta luminosità
- Fascio più lungo
- Luminosità più brillante



Hasta un 50-60% más de luz en carretera

- Diseño especial de la lámpara de alta luminosidad
- Haz luminoso de mayor alcance
- Iluminación más intensa



50-60% mehr Licht auf der Straße

- Spezielles Design für größtmögliche Beleuchtungsstärke
- Größere Leuchtweite
- Hellere Beleuchtung



Street
Legal

12V

Type

ECE

W



Fig.

SKU

EAN

MEGALIGHT PLUS – Halogen headlight lamps

Headlight lamps – upper and lower beam

Lampes principales

Hauptscheinwerferlampen

Lámparas de faro – doble filamento

Lampade per proiettori – abbagliante ed anabbagliante

50440MPU	H4	60/55	P43t	2/12/48 display	1	91618	0043168916189
				1/12/48 display	1	12791	0043168127912
				2/20 blister	1	93361	0043168933612
58520MPU	H7	55	PX26d	2/16/64 display	2	93768	0043168937689
				1/20/80 display	2	12904	0043168129046
				2/20 blister	2	19759	0043168197595
50310MPU	H1	55	P14,5s	2/16/64 display	3	93625	0043168936255
				1/20/80 display	3	12896	0043168128964
				2/20 blister	3	19758	0043168197588

Fig. 1.

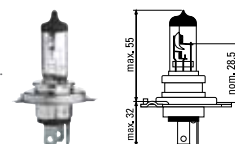

Fig. 2.

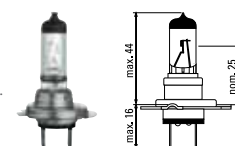
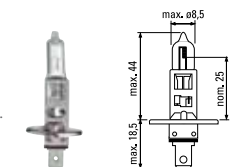

Fig. 3.



Always
change the
headlamps
by pair.



Sportlight



When you really want to see and be seen

Intense blue-white light up to 50% more light on the road, or faster signal

- Higher visibility in peripheral viewing
- Better visibility in extreme weather conditions
- Faster signal, earlier notice - miniature lamps



Lorsque vous voulez vraiment voir et être vu

Une lumière intense bleue-blanche et jusqu'à 50% plus de lumière sur la route, ou un signal et un aperçu plus rapide

- Une visibilité périphérique plus élevée et dans des conditions climatiques extrêmes
- Un signal et un aperçu plus rapide - lampes miniatures



Se volete davvero vedere ed essere visti

Un'intensa luce di colore blu-bianca che garantisce un'illuminazione della strada superiore del 50%

- Visibilità maggiore nella visione periferica "per vedere ed essere visti"
- Migliore visibilità in condizioni atmosferiche difficili
- Segnale più veloce, che permette di essere visti vedere prima - lampade miniature



Para ver y ser visto con claridad

Luz intensa blanca azulada, que ofrece hasta un 50% más de iluminación en carretera

- Mayor visibilidad en el campo de visión periférico
- Mayor visibilidad en condiciones climáticas extremas - lámparas miniatura



Wenn Sie wirklich gut sehen und gut gesehen werden wollen

Intensives blau-weißes Licht mit Xenon Effekt, welches bis zu 50% mehr Licht auf die Straße bringt

- Bessere Sicht in den Außenrandbereichen um zu sehen und gesehen zu werden
- Bessere Sichtbarkeit bei extremen Wetterbedingungen
- Verbesserte und schnellere Reaktionszeit - Miniaturlampen



Type

ECE

W



Fig.

SKU

EAN

SPORTLIGHT – Halogen headlight lamps

Headlight lamps – upper and lower beam

Lampes principales

Hauptscheinwerferlampen

Lámparas de faro – doble filamento

Lampade per proiettori – abbagliante ed anabbagliante

53800SPU	H4	60/55	P43t	2/12/48 display	1	79298	0043168792981
				2/20 blister	1	88790	0043168887908
58320SPU	H7	55	PX26d	2/16/64 display	2	79299	0043168792998
				2/20 blister	2	88789	0043168887892
50310NHSU	H1	55	P14,5s	2/16/64 display	3	90761	0043168907613
				2/20 blister	3	73343	0043168733434
53810NHSU	HB3	60	P20d	2/12/48	4	79304	0043168793049
53820NHSU	HB4	51	P22d	2/12/48	5	79303	0043168793032

SPORTLIGHT - Miniature lamps

Tail, direction, parking and indicator lamps

Feu rouge/clignotant/Feu de position/Répetiteur latéral

Blink-, Brems- und Schlußlichtlampen

Lámparas traseras, marcha atrás e indicadores

Lampade per fanali posteriori, luci di arresto e direzione

1057NH	P21W	21	BA15s	1/10/200	6	45690	0043168456906
				10/200	6	45348	0043168453486
				2/20 blister	6	74983	0043168749831
1077NH	P21/5W	21/5	BAY15d	1/10/200	7	45687	0043168456876
				10/200	7	45346	0043168453462
				2/20 blister	7	74984	0043168749848
2619NH	R5W	5	BA15s	1/10/200	8	45685	0043168456852
				10/200	8	45342	0043168453424
				2/20 blister	8	74985	0043168749855
2641NH	R10W	10	BA15s	1/10/200	8	45684	0043168456845
				10/200	8	45337	0043168453370
				2/20 blister	8	74986	0043168749862
501NH	W5W	5	W2,1x9,5d	10/200	9	76108	0043168761086
				2/20 blister	9	76109	0043168761093

Fig. 1.

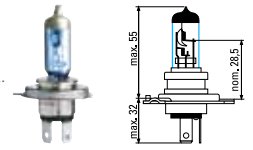

Fig. 2.

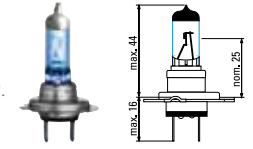

Fig. 3.

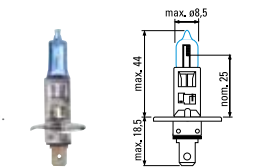

Fig. 3.

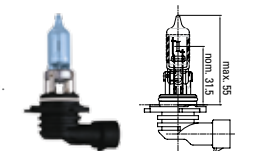

Fig. 4.

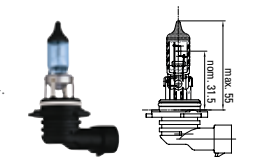

Fig. 6.

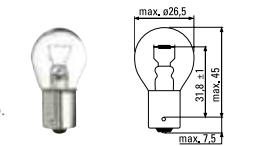

Fig. 7.

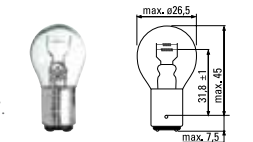

Fig. 8.

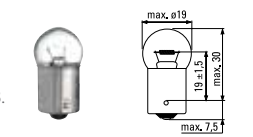
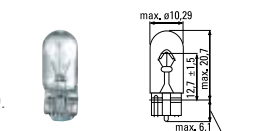

Fig. 9.



Extra Life



Extended long lifetime

Double the life of standard bulbs

- Suitable for Daytime Running Light (DRL) use
- Ensures safe driving during day and night



Durée de vie extra longue

Double la vie des lampes standard

- convenable pour l'utilisation DRL
- pour conduire en sécurité - spécialement conçus pour la conduite de jour comme de nuit



Durata molto lunga

Doppia durata rispetto alle tradizionali lampadine

- Ideale come lampadine DRL (Daytime Running Light)
- Garantisce una guida sicura durante il giorno e la notte



Vida útil prolongada

Duplica la vida útil de las bombillas estándar

- Adecuada para su uso como luz diurna (DRL)
- Garantiza una conducción segura día y noche



Verlängerte Lebensdauer / Superlonglife

Lebensdauerverdoppelung gegenüber Standardglühlampen

- Besonders geeignet auch als Tagfahrlichtlampen-Generation (DRL)
- Sorgt für sicheres Fahren bei Tag und bei Nacht



Street
Legal

Type

ECE

W

Fig.

SKU

EAN

EXTRA LIFE - Headlight lamps

Headlight lamps – upper and lower beam

Lampes principales

Hauptscheinwerferlampen

Lámparas de faro – doble filamento

Lampade per proiettori – abbagliante ed anabbagliante

50440LU_DPU	H4	60/55	P43t	2/12/48 displ	1	17462	0043168174626
				2/20 blister	1	19682	0043168196826
58520LU_DPU	H7	55	PX26d	2/16/64 displ	2	17463	0043168174633
				2/20 blister	2	19686	0043168196864
50310LU_DPU	H1	55	P14,5s	2/16/64 displ	3	17465	0043168174657
				2/20 blister	3	19685	0043168196857
50340LU_DPU	H3	55	PK22s	1/10/100	4	17464	0043168174640

EXTRA LIFE - Miniature lamps

Tail, direction, parking and indicator lamps

Feu rouge/clignotant/Feu de position/Répétiteur latéral

Blink-, Brems- und Schlußlichtlampen

Lámparas traseras, marcha atrás e indicadoras

Lampade per fanali posteriori, luci di arresto e direzione

1057LFD	P21W	21	BA15s	1/10/200	5	77049	0043168770491
				2/20 blister	5	23284	0043168232845
1056LFD	PY21W	21	BAU15s	1/10/200	6	77091	0043168770910
1077LFD	P21/5W	21/5	BAY15d	1/10/200	7	77050	0043168770507
				2/20 blister	7	23285	0043168232852
TU 1122LFD	P21/4W	21/4	BAZ15d	1/10/200	7	77090	0043168770903
2619LFD	R5W	5	BA15s	1/10/200	8	77051	0043168770514
				2/20 blister	8	23286	0043168232869
TU 2641LFD	R10W	10	BA15s	1/10/200	8	77052	0043168770521
TU 7546LFD	C5W	5	SV8,5	1/10/200	9	77054	0043168770545
				2/20 blister	9	23308	0043168233088
TU 930FD	W5W	5	W2,1x9,5d	1/10/200	10	77048	0043168770484
TU 2662LFD	T4W	4	BA9s	1/10/200	11	77059	0043168770590
				2/20 blister	11	23292	0043168232920
TU 52830LFD	H6W	6	BAX9s	1/10/100	12	77053	0043168770538



Fig. 1.

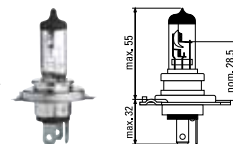

Fig. 2.

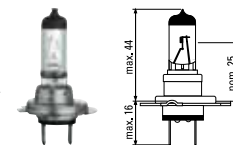

Fig. 3.

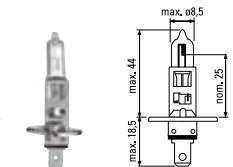

Fig. 4.

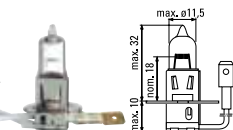

Fig. 5.

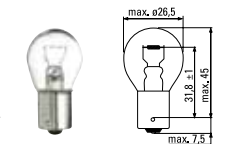

Fig. 6.

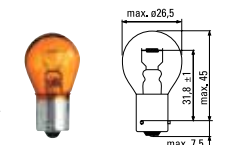

Fig. 7.

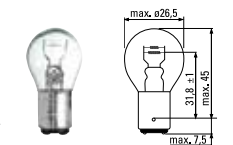

Fig. 8.

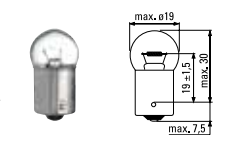

Fig. 9.

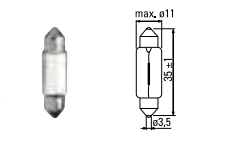

Fig. 10.

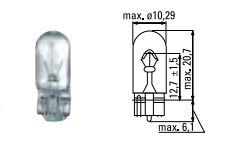

Fig. 11.

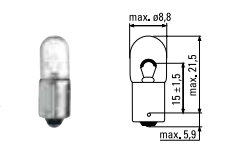
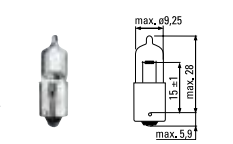

Fig. 12.



Rally



High wattage headlight and foglight lamps for OFF ROAD use only



Lampes phares et anti-brouillard à haute puissance pour l'utilisation 'OFF-ROAD'



Fari anteriori e fari antinebbia ad alto wattaggio esclusivamente per uso OFF ROAD



Faros delanteros y luces antiniebla de alta potencia para uso exclusivo EN VÍAS NO OFICIALES



Hochwattscheinwerfer- und Nebelscheinwerferlampen die speziell für „OFF ROAD“ oder als „RALLYLAMPEN“ genutzt werden können.



Off-road

Type

W



Fig.

SKU

EAN

RALLY – Halogen headlight lamps

Headlight lamps – Rally types are NOT ALLOWED ON PUBLIC ROADS

Lampes principales RALLYE – Lampes rallye UTILISATION SUR ROUTE INTERDITE

Hauptscheinwerferlampen – Rallye-TYPEN SIN IM BEREICH DER STVZO NICHT ZUGELASSEN

Lámparas de faro y proyector - halógena - Las lámparas de rally NO ESTÁN PERMITIDAS EN VÍAS PÚBLICAS

Lampade per proiettori - Alogene - È VIETATO L'IMPIEGO DI LÁMPADE "Rally" su strade pubbliche

52140U		100	P14,5s	1/10/100	1	34874	9004102348740
					1/10 blister	1	35434
50370U		100	P14,5s/R	1/10/100	1	34875	9004102348757
52150U		100	X511	1/10/200	2	38661	0043168386616
					1/10 blister	2	37962
52130U		100	Pk22s	1/10/200	3	34876	9004102348764
					1/10 blister	3	37963
52090U		100/55	P43t	1/10/100	4	37903	0043168379038
52100U		100/80	P43t	1/10/100	4	35974	0043168359740
					1/10 blister	4	35436
52030U		100/80	P45t	1/10/100	5	35975	0043168359757

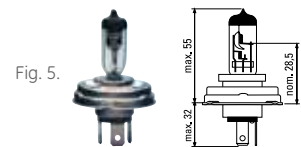
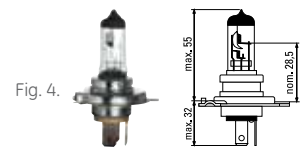
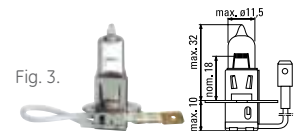
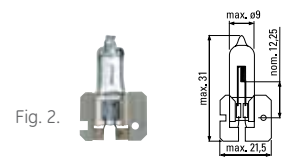
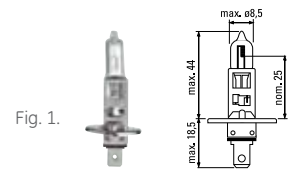

Type

ECE

W



Fig.

SKU

EAN

Headlight lamps - upper and lower beam
Lampes principales
Hauptscheinwerferlampen
Lámparas de faro - doble filamento
Lampade per proiettori - abbagliante ed anabbagliante

H4	50440U	H4	60/55	P43t	1/10/100	1	34454	9004102344544
					1/10 blister	1	17120	0043168354417
					2/20 blister	1	35930	0043168359306
	52070U		60/55	P45t	1/10/100	2	19762	0043168197625
H1	50310/1U	H1	55	P14,5s	1/10/100	3	20727	9004102207276
					1/10 blister	3	17119	0043168354301
H2	50410U	H2	55	X511	1/10/200	4	20734	9004102207344
					1/10 blister	4	38677	0043168386777
H3	50340U	H3	55	Pk22s	1/10/200	5	20729	9004102207290
					1/10 blister	5	17117	0043168354325
H7	58520U	H7	55	PX26d	1/10/100	6	35017	0043168350174
					1/10 blister	6	17123	0043168354356

Fig. 1.

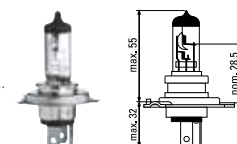

Fig. 2.

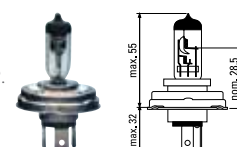

Fig. 3.

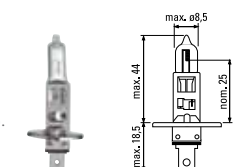

Fig. 4.

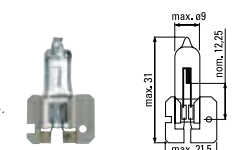

Fig. 5.

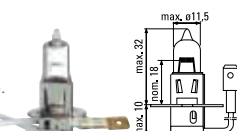
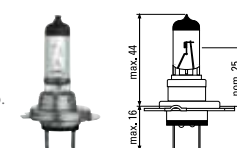

Fig. 6.



12V

GE "Reliable" range

Quality - performance - fully replaceable with OEM lamps

Type

ECE

W



Fig.

SKU

EAN

Headlight lamps – upper and lower beam
Lampes principales
Hauptscheinwerferlampen
Lámparas de faro – doble filamento
Lampade per proiettori – abbagliante ed anabbagliante

H8	53090U	H8	35	PGJ19-1	1/10/100	1	92563	0043168925631
					1/10 blister	1	18254	0043168182546
H9	53100U	H9	65	PGJ19-5	1/10/100	2	92565	0043168925655
					1/10 blister	2	18256	0043168182560
H11	53110U	H11	55	PGJ19-2	1/10/100	1	92567	0043168925679
HB3	53060U	HB3	60	P20d	1/10/100	3	36474	0043168364744
					1/10 blister	3	18266	0043168182669
HB4	53070U	HB4	51	P22d	1/10/100	4	36472	0043168364720
					1/10 blister	4	18267	0043168182676
H10	53080U	H10	42	PY20d	1/10/100	4	12905	0043168129053
R2	52950	R2 Halogen	45/40	P45t	1/10/100	5	35077	9004102350774

Fig. 1.

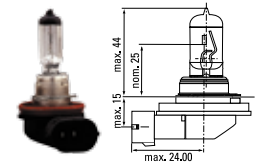

Fig. 2.

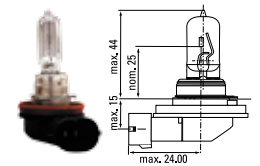

Fig. 3.

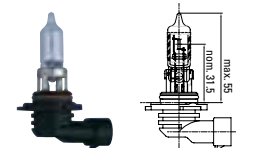

Fig. 4.

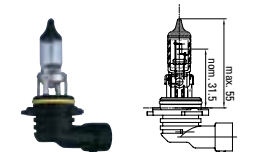
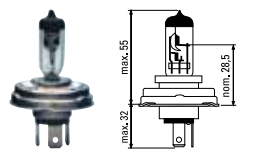
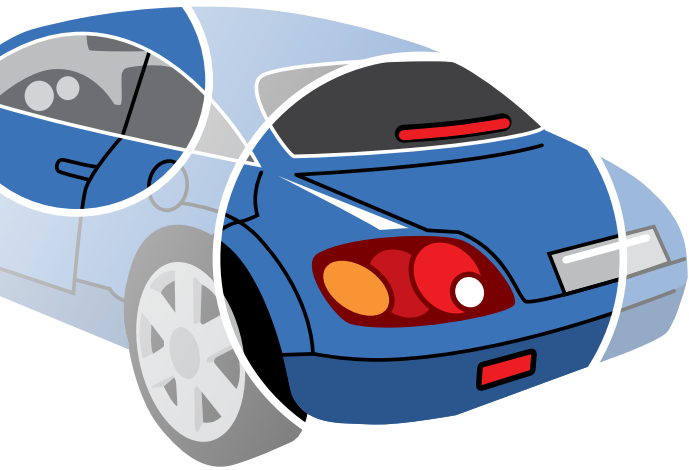

Fig. 5.



Miniature lamps



- side signals, warning lamps
- stop lamps
- fog lamps
- license plate
- reverse lamps

UPGRADE
your car with **GE premium lamps**

Extra Life
better economy for daytime lighting, 2x longer life

SportLight
when you really want to **see and be seen**

Heavy duty, Heavy duty long life

GE "Reliable" range
quality- performance
fully replacable with OEM lamps

P21W



P21/4W



P21/5W





- parking lamps
- dashboard lamps
- interior lamps
- indicator lamps
- side turn signal lamps

PY21W	R5W	R10W	T4W	W5W	C5W
					
●	●	●	●	●	●
	●	●		●	
●	●	●	●		
●	●	●	●	●	●

Type

ECE

W



Fig.

SKU

EAN

Tail, stop and direction lamps

Feu rouge/stop/clignotant

Brems-, Blink- und Schlußlichtlampen

Lámparas traseras, freno e intermitente

Lampade per fanali posteriori, luci di arresto e direzione

1056	PY21W	21	BAU15s	1/10/200	1	37964	0043168379649
				10/200	1	17248	9004102328193
				2/20 blister	1	17133	0043168354073
1057	P21W	21	BA15s	1/10/200	2	37894	0043168378949
				10/200	2	17218	9004102238058
				2/20 blister	2	17131	0043168354066
1058	P21W	21	BA15d	10/200	3	17219	9004102349914
1059	DIN 72601R	18	BA15s	2/20 blister	4	38725	0043168387255
1156		32 CP	BA15s	10/200	2	77369	0043168773690
1077	P21/5W	21/5	BAY15d	1/10/200	5	37896	0043168378963
				10/200	5	17228	9004102238096
				2/20 blister	5	17130	0043168354097
1098		20/5	BA15d	10/200	5	27736	0043168277365
1122	P21/4W	21/4	BAZ15d	10/200	5	17241	9004102238546
				2/20 blister	5	35931	0043168359313
1157	1157 ANSI	32/3 CP	BAY15d	10/200	5	17247	0043168357197
				2/20 blister	5	37969	0043168379694
7440	W21W	21	W3x16d	1/10/100	6	93458	0043168934589
				2/20 blister	6	93447	0043168934473
7440NA	WY21W	21	WX3x16d	1/10/100	7	76090	0043168760904
				2/20 blister	7	76091	0043168760911
7443	W21/5W	21/5	W3x16q	1/10/100	8	93448	00 43168934480
				2/20 blister	8	512863	5994101128631

Fig. 1

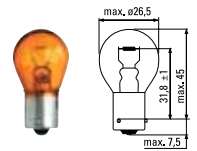

Fig. 2

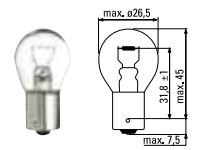

Fig. 3

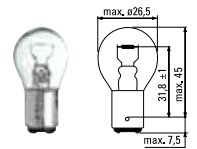

Fig. 4

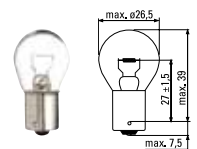

Fig. 5

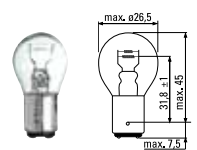

Fig. 6

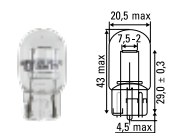

Fig. 7

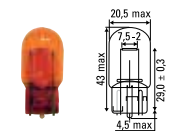
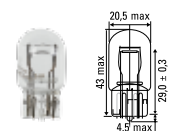

Fig. 8



Type

ECE

W



Fig.

SKU

EAN

Interior lamps

Lampes éclairage intérieur

Lampen für Innenbeleuchtung

Lámparas de interior

Lampade per illuminazione interna

7546	C5W	5	SV8,5-8	1/10/200	1	37912	0043168379120
				10/200	1	27771	9004102238409
				2/20 blister	1	17129	0043168354608
91701		3	SV7	10/200	2	73599	0043168936668
7575		5	SV8,5-8	1/10/200	3	38805	0043168388054
				10/200	3	27781	0043168379557
				2/20 blister	3	37956	0043168379564
7576	DIN 72601K	10	SV8,5-8	1/10/200	3	37913	0043168379137
				10/200	3	27793	9004102238683
				2/20 blister	3	35463	0043168354639
91715		10	SV8,5-8	10/200	5	73600	0043168387781
91735		10	SV8,5-8	1/10/200	4	93436	0043168379908
7592		15	SV8,5-8	10/200	6	27801	9004102349440
				2/20 blister	6	38803	0043168388030
7593		18	SV8,5-8	10/200	6	27803	9004102349457
				2/20 blister	6	38804	0043168388047
7585		10	SV8,5-8	2/20 blister	4	39459	0043168394598

Miniature halogen lamps

Lampes Halogène miniature

Miniatur-Halogenlampen

Lámparas halógenas miniatura

Lampade miniature alogene

58540		5	BA9s	1/20	7	34930	9004102349303
58560		10	BA9s	1/20	7	34926	9004102349266
58570		5	BA15s	1/10/100	8	38847	0043168388474
58580		10	BA15s	1/10/100	8	38848	0043168388481
52830U	H6W	6	BAX9s	1/10/100	9	38849	0043168388498
				1/10 blister	9	38850	0043168388504

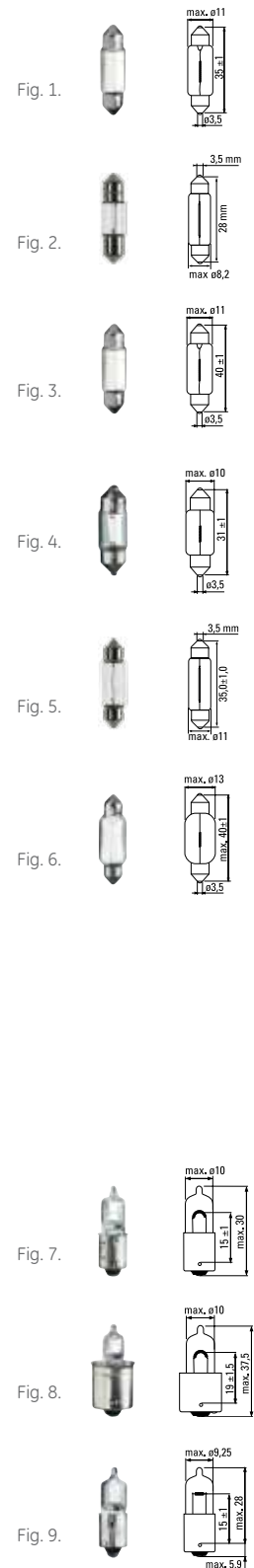



Tail, direction, parking and indicator lamps
 Feu rouge/clignotant/Feu de position/Répétiteur latéral
 Blink-, Brems- und Schlußlichtlampen
 Lámparas traseras, marcha atrás e indicadoras
 Lampade per fanali posteriori, luci di arresto e direzione

2618	R5W	5	BA15d	10/200	1	17252	9004102349969
				2/20 blister	1	38791	0043168387910
2619	R5W	5	BA15s	1/10/200	2	37897	0043168378970
				10/200	2	17253	9004102238270
				2/20 blister	2	17136	0043168353984
2619T	R5W	5	BA15s	10/200	3	20112	0043168201124
2641	R10W	10	BA15s	1/10/200	2	37899	0043168378994
				10/200	2	17256	9004102238348
				2/20 blister	2	17134	0043168354059
2641T	R10W	10	BA15s	10/200	3	20113	0043168201131
2696	DIN 72601J	2	BA7s	10/200	4	27393	9004102349242
				2/20 blister	4	38855	0043168388559
2656		3	BA9s	10/200	5	26741	0043168936927
2660		2	BA9s	10/200	5	26742	9004102349358
				2/20 blister	5	37960	0043168379601
2662	T4W	4	BA9s	1/10/200	6	37900	0043168379007
				10/200	6	27347	9004102238379
				2/20 blister	6	17137	0043168354509
2683		3	E10	2/20 blister	7	38841	0043168388412
5301		1,2	W2x4,6d	1/10/200	8	42804	0043168379076
				10/200	8	42799	9004102238669
				2/20 blister	8	35451	0043168354516
91605		2	W2x4,6d	10/200	8	27872	0043168936521
927122		30mA	W2x4,6d	10/200	8	27880	0043168936767

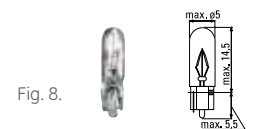
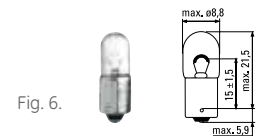
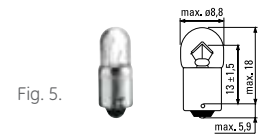
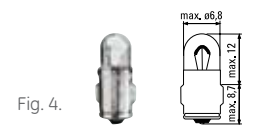
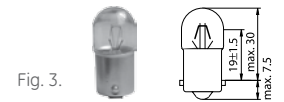
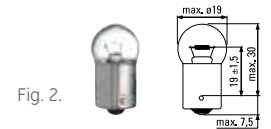
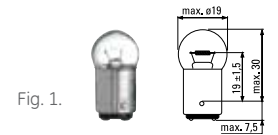

Type	ECE	W			Fig.	SKU	EAN
------	-----	---	--	--	------	-----	-----

Wedge base lamps with and without plastic cap
 Lampes "wedge base" avec ou sans culot plastique
 Glassockellampen mit und ohne Steckfassung
 Lámparas con casquillo de vidrio y lámparas con base de plástico
 Lampade con attacco vetro e/o in plastica

91609 PS*		0,5	W2x4,6d	10/200	1	93678	0043168936781
5301 PS*		1,2	B8,5d	1/10/200	2	93438	0043168379885
				2/20 blister	2	39462	0043168394628
91641 PS*		1,2	B8,4d	10/200	3	93673	0043168936736
91645 PS*		2	BX8,4d	10/200	4	93656	0043168936569
91646 PS* 14V		1,12	B8,4d	10/200	5	93657	0043168936576
5301 PS2*		1,2	B8,3d	1/10/200	6	93439	0043168387750
				2/20 blister	6	39461	0043168394611
5303 PS*		2	B8,5d	10/200	7	93659	0043168936590
91665 PS*		2	B8,3d	10/200	7	93660	0043168936606
91671 PS*		1,2	B8,3d	10/200	8	93661	0043168936613
91695 PS* 14V		1,4	HRQ	10/200	9	93664	0043168936644
91696 PS*		1,8	EBS R11	10/200	10	93665	0043168936651
504	W3W	3	W2,1x9,5d	1/10/200	11	41952	0043168379106
				10/200	11	27887	9004102238492
				2/20 blister	11	35452	0043168354523
501	W5W	5	W2,1x9,5d	1/10/200	11	41961	0043168379113
				10/200	11	27888	0043168924580
				2/20 blister	11	17138	0043168354530
91625 Blue	W5W	5	W2,1x9,5d	10/200	12	27895	0043168936552
501 Amber	WY5W	5	W2,1x9,5d	10/500	13	92465	0043168924658
				2/20 blister	13	90199	0043168901994
921	W16W	16	W2,1x9,5d	1/10/100	14	12910	0043168129107
				10/200	14	21513	0043168215138

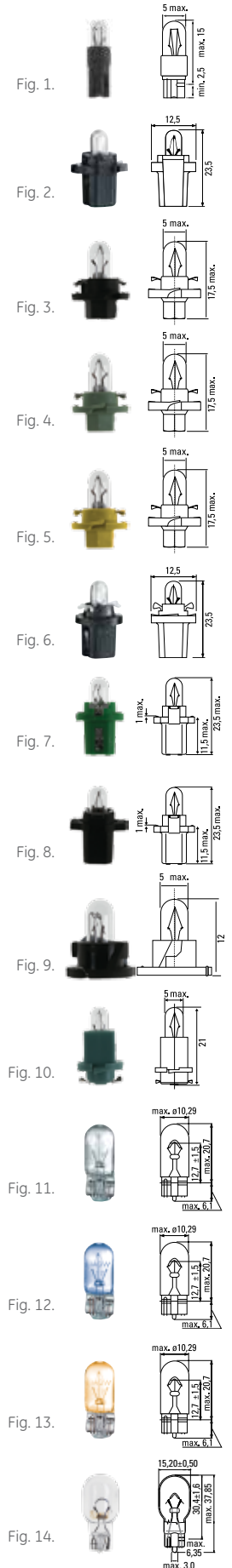

* PS - Plastic cap

Heavy Duty Long Life



24V Truck lamps with longer life and increased robustness



Les lampes 24V pour les poids lourds avec une durée de vie allongée et une résistance accrue



Lampade per Camion : 24V, durata di vita e robustezza superiori alle lampade standard



Lámparas de camión de 24v, con una duración de vida más larga y una mayor solidez



24V Lampen für LKW und Busse mit längerer Lebensdauer und höherer Robustheit



Type

ECE

W



Fig.

SKU

EAN

HEAVY DUTY LONG LIFE - Halogen headlight lamps

Headlight lamps – upper and lower beam

Lampes principales

Hauptscheinwerferlampen

Lámparas de faro – doble filamento

Lampade per proiettori – abbagliante ed anabbagliante

50320/1U_HDL	H1	70	P14,5s	1/10/100	1	61493	0043168614931
50350U_HDL	H3	70	Pk22s	1/10/200	2	61496	0043168614962
50450HDLU	H4	75/70	P43t	1/10/100	3	61494	0043168614948
58521HDLU	H7	70	Px26d	1/10/100	4	61495	0043168614959

HEAVY DUTY LONG LIFE - Miniature lamps

Tail, direction, parking and indicator lamps

Feu rouge/clignotant/Feu de position/Répétiteur latéral

Blink-, Brems- und Schlußlichtlampen

Lámparas traseras, marcha atrás e indicadores

Lampade per fanali posteriori, luci di arresto e direzione

1060HDL	P21W	21	BA15s	10/200	5	77095	0043168770958
1061HDL	P21W	21	BA15d	10/200	6	77097	0043168770979
1073NAHDL	PY21W	21	BAU15s	10/200	7	77329	0043168773294
2626HDL	R5W	5	BA15d	10/200	8	77336	0043168773362
2627HDL	R5W	5	BA15s	10/200	9	77334	0043168773345
2643HDL	R10W	10	BA15s	10/200	10	77342	0043168773423
2661HDL	T4W	4	BA9S	10/200	11	27341	0043168614856

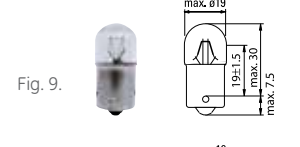
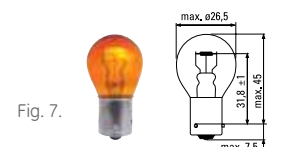
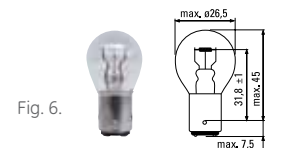
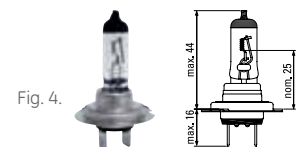
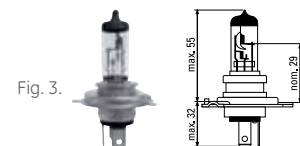
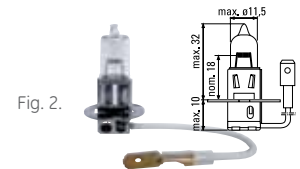
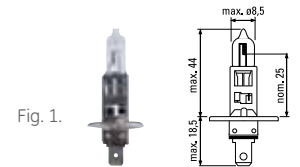

Type

ECE

W



Fig.

SKU

EAN

Headlight lamps - upper and lower beam

Lampes principales

Hauptscheinwerferlampen

Lámparas de faro - doble filamento

Lampade per proiettori - abbagliante ed anabbagliante

H1	50320/1U	H1	70	P14,5s	1/10/100	1	23793	9004102237938
					1/10 blister	1	38679	0043168386791
H2	50420U	H2	70	X511	1/10/200	2	23784	9004102237846
H3	50350U	H3	70	Pk22s	1/10/200	3	21149	9004102211495
					1/10 blister	3	38674	0043168386746
	50400U Rally*		100	Pk22s	1/10/200	3	38659	0043168386593
H4	50450U	H4	75/70	P43t	1/10/100	4	38836	0043168388368
					1/10 blister	4	91579	0043168915793
	52710U Rally*		100/70	P43t	1/10/100	4	38664	0043168386647
H7	58521U	H7	70	Px26d	1/10/100	5	38838	0043168388382

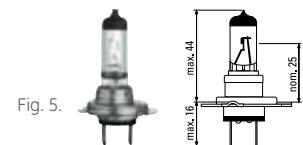
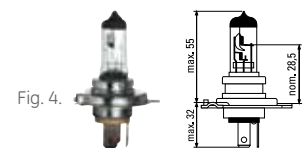
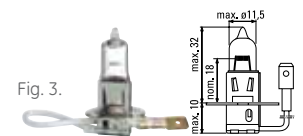
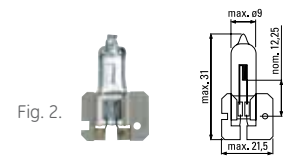
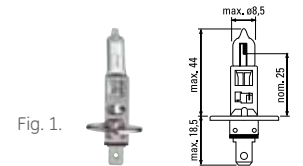

Type

ECE

W



Fig.

SKU

EAN

Tail, direction, parking and indicator lamps
 Feu rouge/clignotant/Feu de position/Répétiteur latéral
 Blink-, Brems- und Schlußlichtlampen
 Lámparas traseras, marcha atrás e indicadoras
 Lampade per fanali posteriori, luci di arresto e direzione

2626	R5W	5	BA15d	10/200	1	17308	9004102349990
2626HD*	R5W	5	BA15d	10/200	1	17309	9004102349983
91426		10	BA15d	10/200	2	93650	0043168936507
2627	R5W	5	BA15s	10/200	3	17310	9004102238294
2627HD*	R5W	5	BA15s	1/10/200	3	37898	0043168378987
				10/200	3	17311	9004102349396
				2/20 blister	3	38792	0043168387927
2643	R10W	10	BA15s	10/200	4	17312	9004102238355
2643HD*	R10W	10	BA15s	1/10/200	4	37958	0043168379588
				10/200	4	17313	9004102349402
				2/20 blister	4	38794	0043168387941
2692	DIN 72601J	3	BA7s	10/200	5	27380	9004102349259
2661	T4W	4	BA9s	10/200	6	27327	9004102238393
2661HD*	T4W	4	BA9s	10/200	6	27341	9004102349334
				2/20 blister	6	38795	0043168387958
2663		2	BA9s	10/200	7	27355	9004102349341
5305	W3W	3	W2,1x9,5d	1/10/200	8	93443	0043168387767
				10/200	8	27897	0043168132619
91622	W5W	5	W2,1x9,5d	10/200	8	27893	0043168936545

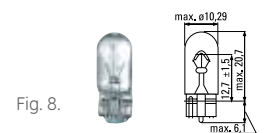
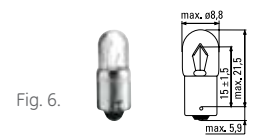
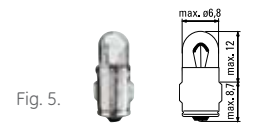
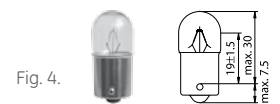
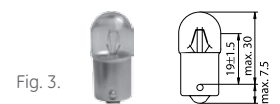
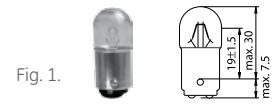

* Supported heavy duty (HD) lamps - Lampes renforcées (anti vibration) - Heavy-Duty-Lampen - Lámparas reforzadas HD - Lampade rinforzate HD

Type

ECE

W



Fig.

SKU

EAN

Interior lamps

Lampes éclairage intérieur

Lampen für Innenbeleuchtung

Lámparas de interior

Lampade per illuminazione interna

7552	C5W	5	SV8,5-8	10/200	1	27773	9004102238454
					2/20 blister	1	38800 004316838809
91716		10	SV8,5-8	10/200	1	73601	0043168936699
91702		3	SV7	10/200	2	73604	0043168936743
7579		5	SV8,5-8	10/200	3	27788	0043168388061
					2/20 blister	3	38801 0043168388016
7580		10	SV8,5-8	10/200	3	27795	9004102349419
					2/20 blister	3	38802 0043168388023
7594		15	SV8,5-8	10/200	4	27802	0043168388078
7595	DIN 72601K	18	SV8,5-8	10/200	4	27806	0043168388092
91602		1,2	W2x4,6d	10/200	5	27870	0043168132565
91606		2	W2x4,6d	10/200	5	27879	0043168936538
5302PS*		1,2	B8,5d	1/10/200	6	93442	0043168387774
				10/200	6	13269	0043168132695
91693		1,2	EBS R11	10/200	7	93662	0043168936620

Fig. 1.

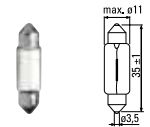

Fig. 2.



Fig. 3.

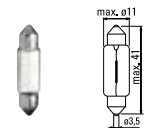

Fig. 4.

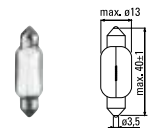

Fig. 5.

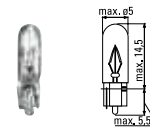
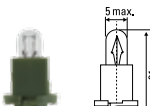

Fig. 6.



Fig. 7.



* PS - Plastic cap

Type

ECE

W



Fig.

SKU

EAN

Tail, stop and direction lamps
 Feu rouge/Stop/Clignotant
 Rücklicht-, Brems- und Schlußlichtlampen
 Lámparas traseras, freno e intermitente
 Lampade pe fanali posteriori, luci di arresto e direzione

1115		15	BA15s	10/200	1	17238	0043168387422
1117	DIN 72601R	18	BA15s	10/200	1	17240	0043168387446
91376		20	BA15d	10/200	2	93646	0043168936460
1060	P21W	21	BA15s	10/200	3	17221	9004102238072
1060HD*	P21W	21	BA15s	1/10/200	3	37895	0043168378956
				10/200	3	17222	9004102348849
				2/20 blister	3	38726	0043168387262
1061	P21W	21	BA15d	10/200	4	17223	9004102349938
1061HD*	P21W	21	BA15d	10/200	4	17225	9004102349921
1073	PY21W	21	BAU15s	10/200	5	17250	9004102344520
1078	P21/5W	21/5	BAY15d	1/10/200	6	38731	0043168387316
				10/200	6	17232	9004102238133
				2/20 blister	6	38727	0043168387279
91386		21/5	BA15d	10/200	6	93648	0043168936484
91242		35	BA20s	1/10/100	7	93637	0043168936378

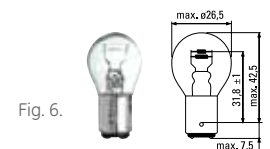
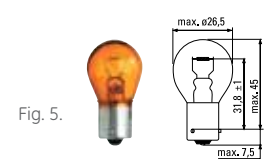
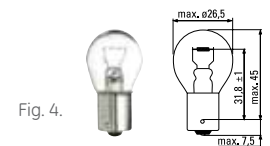
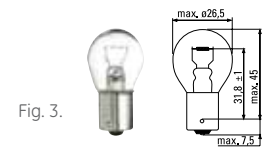
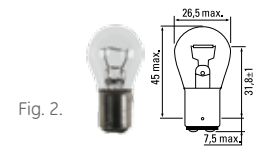
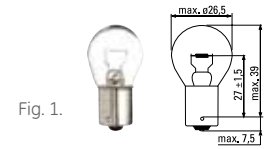

* Supported heavy duty (HD) lamps
 Lampes renforcées (anti vibration)
 Heavy-Duty-Lampen
 Lámparas reforzadas HD
 Lampade rinforzate HD

Emergency Kits

Coffrets de Secours

Ersatzdose

Estuche de repuesto

Scatola lampade di scorta

CONTENT			
H4, PY21W, P21/5W, P21W, R5W, C5W, W5W, T4W, normal fuses 10A, 15A, 20A, mini fuses 7,5A, 10A, 20A	1/10	70693	0043168706933
H1, PY21W, P21/5W, P21W, R5W, C5W, W5W, T4W, normal fuses 10A, 15A, 20A, mini fuses 7,5A, 10A, 20A	1/10	70706	0043168707060
H7, PY21W, P21/5W, P21W, R5W, C5W, W5W, T4W, normal fuses 10A, 15A, 20A, mini fuses 7,5A, 10A, 20A	1/10	70694	0043168706940
H1+H7, PY21W, P21/5W, P21W, R5W, C5W, W5W, T4W, normal fuses 10A, 15A, 20A, mini fuses 7,5A, 10A, 20A	1/10	70707	0043168707077
H1, P21/5W, P21W, R5W, C5W, normal fuses 10A, 15A, 20A	1/10	92751	0043168927512
H4, P21/5W, P21W, R5W, C5W, normal fuses 10A, 15A, 20A	1/10	92752	0043168927529
H7, P21/5W, P21W, R5W, C5W, normal fuses 10A, 15A, 20A	1/10	92753	0043168927536
H1+H7, P21/5W, P21W, R5W, C5W, 10A, 15A, 20A	1/10	92755	0043168927550



Displays

GE wall display

Vacuum formed plastic body and positions for boxes, foam insert for miniature lamps.
 Defined content for 161 lamps - main halogens and miniatures. Shipped as empty (sku 88653) or filled (sku 82881).



Lamp type	Lamp pcs	
H1	6	<i>in single boxes</i>
H4	5	<i>in single boxes</i>
H7	10	<i>in single boxes</i>
P21W	20	<i>without box, in the foam</i>
PY21W	10	<i>without box, in the foam</i>
P21/5W	30	<i>without box, in the foam</i>
R5W	20	<i>without box, in the foam</i>
C5W	20	<i>without box, in the foam</i>
W5W	20	<i>without box, in the foam</i>
W1,2W	20	<i>without box, in the foam</i>
TOTAL	161	

GE wall or counter display



Type	Blisters		Code
Empty display	-	<i>packed by 12 pcs, min. order qty 12 pcs</i>	75040
Sportlight		20 twinblisters	75041
Megalight Ultra		20 twinblisters	75042

Packaging *Emballage – Verpackungen – Embalaje – Imballo*

New GE auto aftermarket pack concept

GE Lighting – has been a leading supplier to Automotive OEM and Aftermarket customers throughout the world for many decades. We continue our pioneering work to offer advanced solutions and benefits that can fulfill our customers' needs.

Our brand is the symbol of our heritage, and of the quality and trust we have delivered to our customers. It embodies our commitment to anticipate and meet their changing needs. It represents the imagination we use to address those needs in a manner that reflects our values.

As a result of continuous efforts to fulfill our customers' changing needs - GE has developed a new packaging concept. The main objective of our redesigned packaging is to enhance the shopping experience and drive upsell.

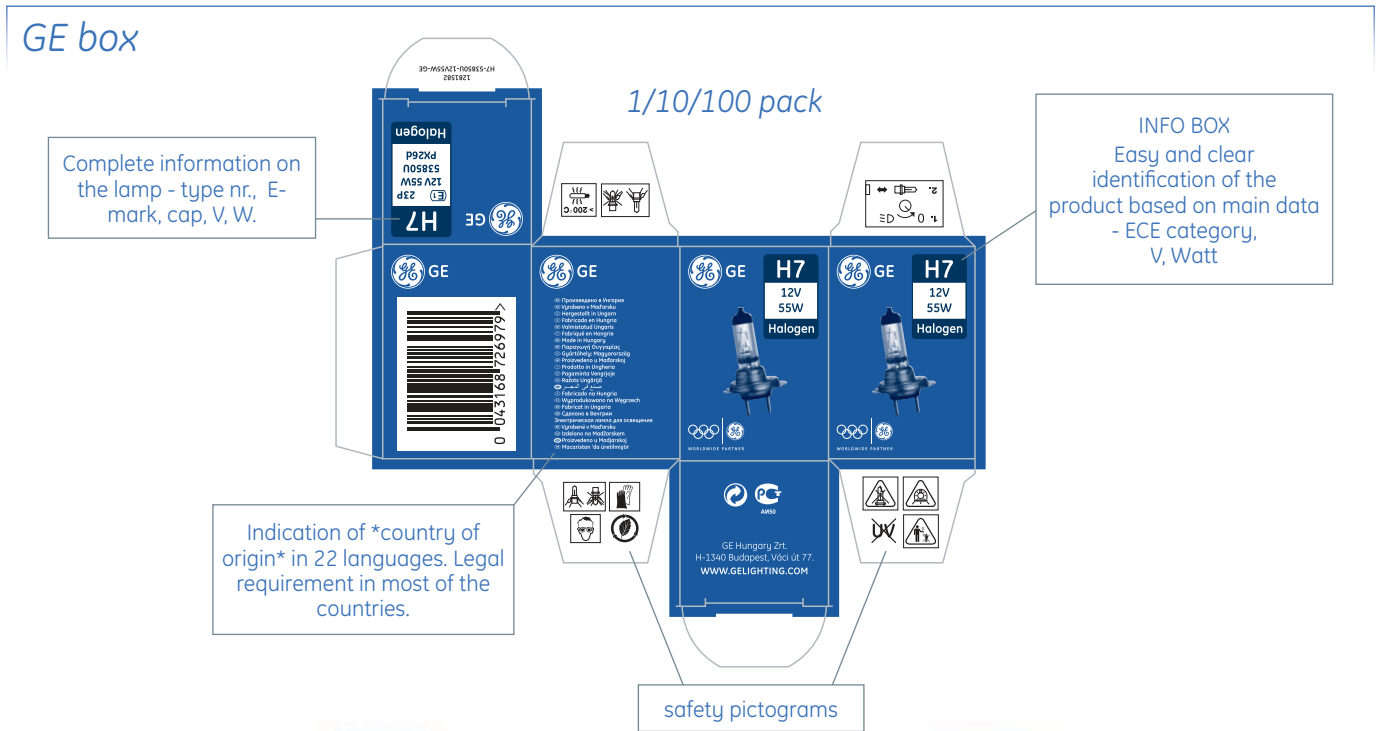



Colour coded packages tied directly to POS messaging for easy identification:

STANDARD range - describe the standard categories, D2 discharge, 12V-24V halogen and miniature lamps

PREMIUM range with feature/benefit logo, explain how one product differs from another, and why it is most appropriate for its task - rationalize the move to upsell in the halogen and miniature lamp categories

Standard Packaging

D2 gas discharge lamps

12V halogen and miniature lamps

24V halogen and miniature lamps

Premium Packaging

Megalight
ultra

Megalight
plus

Sportlight

Extra life

Heavy duty,
Long life

Rally

GE Blister range

Product Code	Type	Designation	Simplified number	Lamp in blister	Wattage	Volt	EAN code
17119	50310U	H1	04	1	55W	12V	0043168354301
35932	50310U	H1/A	06	1	55W	12V	0043168359320
19758	50310MPU	H1 Megalight Plus 50	04 MPU	2	55W	12V	0043168197588
96948	50310XU	H1 Megalight Ultra - Plus 90	04XU	2	55W	12V	0043168969482
19685	50310LU_DPU	H1 Extra Life	04 DPU	2	55W	12V	0043168196857
73343	50310NHSU	H1 Sportlight	04 NHSU	2	55W	12V	0043168908344
35434	52140U	H1/1 Rally - offroad	104	1	100W	12V	0043168354349
38679	50320U	H1	74	1	70W	24V	0043168386791
38677	50410U	H2	02	1	55W	12V	0043168386777
37962	52150U	H2 Rally -offroad	107	1	100W	12V	0043168379625
17117	50340U	H3	05	1	55W	12V	0043168354325
37963	52130U	H3 Rally-offroad	105	1	100W	12V	0043168379632
38674	50350U	H3	75	1	70W	24V	0043168386746
17123	58520U	H7	03	1	55W	12V	0043166354356
88789	58320NHSU	H7 Sportlight	03 NHSU	2	55W	12V	0043168887892
19759	58520MPU	H7 Megalight Plus 50	03 MPU	2	55W	12V	0043168197595
74154	58520SXU	H7 Megalight Ultra - Plus 90	03SXU	2	55W	12V	0043168741545
19686	58520LU_DPU	H7 Extra Life	03 DPU	2	55W	12V	0003168196864
45691	58521U	H7 24V	77	1	70W	24V	0043168456913
17120	50440U	H4	01	1	60/55W	12V	0043168354417
35930	50440U	H4	01	2	60/55W	12V	0043168359306
91579	50450U	H4	71	1	60/55W	24V	0043168915793
93361	50440MPU	H4 MegaLight Plus 60	01 MPU	2	60/55W	12V	0043168933612
74153	50440SXU	H4 MegaLight Ultra - Plus 90	01 SXU	2	60/55W	12V	0043168741538
19682	50440LU_DPU	H4 Extra Life	01DPU	2	60/55W	12V	0043168196826
88790	53800NHSU	H4 Sportlight	01 NHSU	2	60/55W	12V	0043168887908
35436	52100U	H4 Rally-offroad	101	1	100/80W	12V	0043168354363
18266	53060U	HB3	07	1	60W	12V	0043168182669
18267	53070U	HB4	09	1	51W	12V	0043168182676
18254	53090U	H8	13	1	35W	12V	0043168182546
18256	53100U	H9	15	1	65W	12V	0043168182560
17131	1057	P21W	21	2	21W	12V	0043168354066
23284	1057LFD	P21W Extra Life	21D	2	21W	12V	0043168232845
74983	1057NH	P21W Sportlight	21NH	2	21W	12V	0043168749831
38725	1059	72601R	36	2	18W	12V	0043168387255
17130	1077	P21/5W	23	2	21/5W	12V	0043168354097
23285	1077LFD	P21/5W Extra Life	23D	2	21/5W	12V	0043168232852
74984	1077NH	P21/5W Sportlight	23NH	2	21/5W	12V	0043168749848
38727	1078	P21/5W	93	2	21/5W	24V	0043168387279
38728	1098	20/5W	48	2	20/5W	12V	0043168387286
35931	1122	P21/4W	20	2	21/4W	12V	0043168359313
37969	1157	1157 ANSI	39	2	32/3W	12V	0043168379694
17133	1056	PY21W	22	2	21W	12V	0043168354073
17136	2619	R5W	24	2	5W	12V	0043168353984
23286	2619LFD	R5W Extra Life	24D	2	5W	12V	0043168232869
74985	2619NH	R5W Sportlight	24NH	2	5W	12V	0043168749855
17137	2662	T4W	26	2	4W	12V	0043168354509
23292	2662LFD	T4W Extra Life	26D	2	4W	12V	0043168232920
38791	2618	R5W	37	2	5W	12V	0043168387910
38792	2627HD	R5W Heavy Duty	87HD	2	5W	24V	0043168387927
17134	2641	R10W	30	2	10W	12V	0043168354059
74986	2641	R10W Sportlight	30NH	2	10W	12V	0043168749862
38794	2643HD	R10W Heavy Duty	80HD	2	10W	24V	0043168387941
37960	2660	2660	38	2	2W	12V	0043168379601
38795	2661HD	T4W Heavy Duty	86HD	2	4W	24V	0043168387958
38855	2696	72601J	47	2	2W	12V	0043168388559
39462	5301PS	W1,2W	60	2	1,2W	12V	0043168394628
39461	5301PS2	W1,2W	61	2	1,2W	12V	0043168394611
35451	5301	W1,2W	29	2	1,2W	12V	0043168354516
35452	5304	W3W	27	2	3W	12V	0043168354523
17138	501	W5W	28	2	5W	12V	0043168354530
76109	501NH	W5W Sportlight	28NH	2	5W	12V	0043168761093
90199	501A	WY5W	33	2	5W	12V	0043168901994
39463	7538	7538	41	2	3W	12V	0043168394635
17129	7546	C5W	25	2	5W	12V	0043168354608
23308	7546LFD	C5W Extra Life	25D	2	5W	12V	0043168233088
38800	7552	C5W	85	2	5W	24V	0043168388009
37956	7575	7575	40	2	5W	12V	0043168379564
35463	7576	DIN 72601K	31	2	10W	12V	0043168354639
38801	7579	7579	90	2	5W	24V	0043168388016
38802	7580	7580	91	2	10W	24V	0043168388023
39459	7585	7585	32	2	10W	12V	0043168394598
38803	7592	72601K	42	2	15W	12V	0043168388030
38804	7593	72601K	43	2	18W	12V	0043168388047
38850	52830	H6W	62	1	6W	12V	0043168388504
93447	7440	W21W	50	2	21W	12V	0043168934473
512863	7443	W21/5W	49	2	21/5W	12V	5994101128631
76091	7440NA	WY21W	51	2	21W	12V	0043168760911

Our redesigned packaging has the following **advantages**:

GLOBAL: packages reflect a *world view*, display the elements of environmental and regulatory requirements, use multiple languages

TRUSTED: make the purchase easier and clearer, simplified messaging that is repeated on all platforms

PRECISE: package information is clear and states features prominently

APPROACHABLE, SIMPLE: Easy to understand and right for the purchaser, helping them to decide which product is good for them. Provides differentiation between standard range and premium ranges.

GE blister

The diagram illustrates the design of a GE blister pack for an H4 12V 60/55W lamp. It features two views: a front view on the left and a back view on the right. Callouts point to specific design elements:

- Info circle with simplified nr. that allows quick search/identification in the GE lampguide. Clear and simple information on the specific product**: Points to the '01 H4 12V 60/55W' code.
- description of the lamp function in 8 languages**: Points to the multi-language text on the front view.
- country of origin in 22 languages**: Points to the multi-language text on the back view.
- safety pictograms**: Points to the icons at the bottom of the back view.
- original equipment logo + translation in 8 languages, emphasizing GE OEM presence**: Points to the 'original equipment la qualité d'origine' text on the front view.
- lamp drawing with E-mark**: Points to the technical drawing and 'Homologation R37 (E) 10P' on the back view.



Symbols used on the packaging

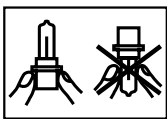

Do not touch with bare fingers



Operation only in luminaire installations with protective shield



No disposal of as household waste



Don't let children play with bulbs



For removal and installation use appropriate eye protection



No operation of lamps with scratched or damaged glass bulb



Dangerous voltage

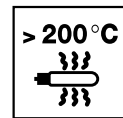

Beware of temperature



Installation and servicing of electronic device only by qualified electrical employees

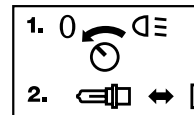

Switch off light before re-lamping



For removal and installation use appropriate gloves



Not suitable for household use



Read attached instructions before use



Use as vehicle lamp 12V or 24V

Base stamps on the GE automotive lamps



Halogen auto lamp marking



Miniature auto lamp marking

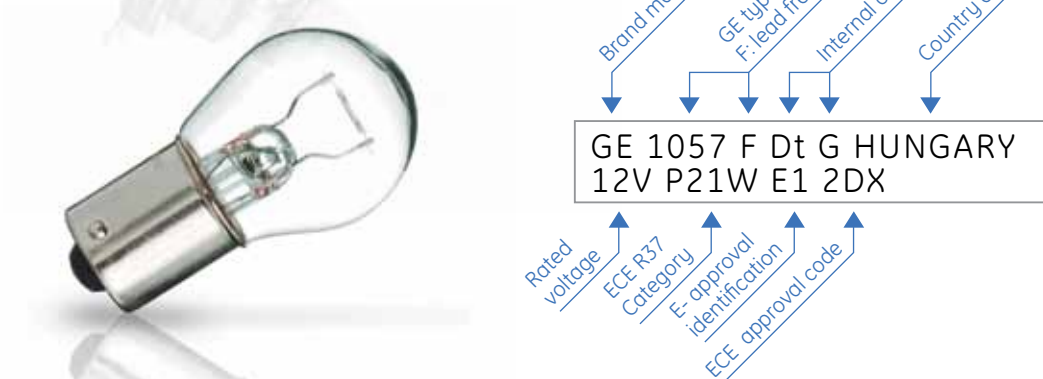

Lamp bases

Culots

Sockelübersicht

Casquillos de lámparas

Attachi lampade



BA7s

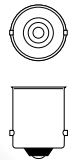

BA9s



BA15s



BAU15s



BA15d



BAY15d



BAZ15d



BAX9s



P14,5s/R



P14,5s

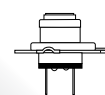

PX26d



E10

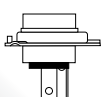

P43t

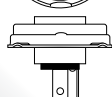

P45t



PK32d-3

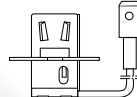

PK22s

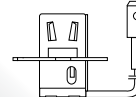
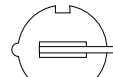

PK22s/R



SV8,5



P32d-2



P32d-3

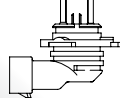
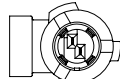

PY20d

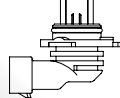
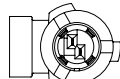

P20d

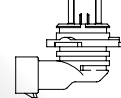
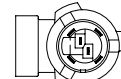

P22d



W2,1x9,5d



W2x4,6d

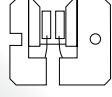
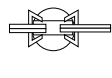

X511

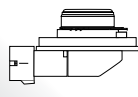

PGJ19

ALBANIA

VSD Merkur doeel
Sales representative of
GE Hungary Kft.
Bulv. Zogu I-re Pallati 103/68
Tirane
ALBANIA
Tel: (355) 4 226 4807

**ALGERIA, GHANA, LYBIA,
MOROCCO, NIGERIA, TUNISIA**

GE Hungary Kft.
1044 Budapest, Váci út 77.
HUNGARY
Tel: (36) 1 231 5280
Fax: (36) 1 231 5121

**ANGOLA, BOTSWANA, KENYA,
MADAGASCAR, MAURITIUS,
MOZAMBIQUE, NAMIBIA,
TANZANIA, ZAMBIA, ZIMBABWE**

GE South Africa - Consumer and
Industrial
Unit 4, 130 Gazelle Avenue,
Corporate Park, Midrand 1685
SOUTH AFRICA
Tel: (27) 11 237 0000
Fax: (27) 11 314 7518

ARGENTINA

GE Iluminacion S.A.
Edificio Uruguay III
Virasoro 2656, 2° PISO
(B1643HDB) Beccar, Buenos Aires
ARGENTINA
Tel: (54) 11 5556 3300
Fax: (54) 11 4736 6616

AUSTRALIA

GE Lighting Australia Ltd.
125-127 Long Street
Smithfield, NSW 2164
AUSTRALIA
Tel: (61) 2 8788 6911
Fax: (61) 2 8788 7224

AUSTRIA

GE Lighting GmbH
Eisenstr. 5
65428 Rüsselheim
GERMANY
Tel: (49) 594398 4581
Fax: (49) 594398 4582

**BAHRAIN, IRAQ, JORDAN,
KUWAIT, LEBANON, OMAN,
PAKISTAN, QATAR, UAE, YEMEN**

GE International Inc.
City Tower II, Sheikh Zayed Rd
P.O. Box 52905, Dubai
UAE
Tel: (971) 4 3310 444
Fax: (971) 4 3315 930

BOSNIA AND HERZEGOVINA

Media Light d.o.o
Exclusive agent of GE Hungary Kft.
Cesta na Brdo 109
1000 Ljubljana
SLOVENIA
Tel: (386) 1 5304366
Fax: (386) 1 5304361

BRAZIL, URUGUAY

GE Hungary Kft.
1044 Budapest
Váci út 77
HUNGARY
Tel: (36) 1 399 1100
Fax: (36) 1 399 1672

BULGARIA

GELL-Bulgaria
Str. Dragan Tzankov 36,
1040 Sofia
BULGARIA
Tel: (359) 2 973 3148
Fax: (359) 2 971 4384

CANADA

GE Lighting Canada
468 South Service Road E,
Oakville, Ontario L6J 2X6
CANADA
Tel: (1) 877 259 0941

**CARIBBEAN
& CENTRAL AMERICA**

General Electric Company
790 N.W. 107 Avenue, Suite 204
Miami, Florida 33172
USA
Tel: (1) 305 551 5114
Fax: (1)305 551 5116

CHILE, BOLIVIA

General Electric de Chile S/A
Casilla 2103
Av. Vicuna Mackenna 2385,
Santiago
CHILE
Tel: (56) 2 555 3031
Fax: (56) 2 556 7329

CHINA

GE Consumer & Industrial
Shanghai Office
(GE Enterprise Development Co., Ltd)
(GE Lighting Co., Ltd)
22F~24F, Building C, Hi-Tech
Building, 900 Yishan Road,
PC: 200233
Shanghai
P.R. CHINA
Tel: (86) 21 24013333
Fax: (86) 21 64857177

COLOMBIA

GE Lighting, Colombia
Carrera 5 No. 81-50 Apto 204
El Pinar, Alto, Santafe de Bogota
COLOMBIA
Tel: (58) 212 902 5131
Fax: (58) 212 902 5158

CROATIA

Media Light d.o.o.
Exclusive agent of GE Hungary Kft.
Lighting and Power Protection
Cesta na Brdo 109
1000 Ljubljana
SLOVENIA
Tel: (386) 1 530 4366
Fax: (386) 1 530 4361

CYPRUS, MALTA

General Electric Medical Systems SA
156 Kyprou Av. & 91
Konstantinoupoleos Str.
164 51 Argyroupolis, Athens
GREECE
Tel: (30) 210 9690 669
Fax: (30) 210 9625 931

CZECH REPUBLIC

GE Industrial s.r.o.
Bucharova 2641/14
158 00 Praha
CZECH REPUBLIC
Tel: (420) 602 115 021,
(420) 602 506 374

DENMARK

GE Lighting A/S
Park Alle 295
2605 Brøndby
DENMARK
Tel: (45) 8040 4945
Fax: (45) 8040 4947

EGYPT

GE International Operations
54 Lebanon Street
Mohandessin, Giza
EGYPT
Tel: (20) 2 301 8060 or 8065
Fax: (20) 2 303 1082

ESTONIA, LATVIA, LITHUANIA

GE Power Controls S.A.
ul. Leszczynska 6
43-300 Bielska Biala
POLAND
VAT no. NIP 526-10-30-824
Registration: REGON 011165913 KRS
0000073794, Sad Rejonowy dla m. st.
Warszawy, XIII Wylczial
Gospodarzy
Krajowego Rejestru Sadowego
Initial Capital 9,365,500,00 PLN
Sales office: ul. Syrokomli 6
03-335 Warszawa
Tel: (48) 22 519 76 00
Fax: (48) 22 519 76 02

FINLAND

GE Consumer & Industrial Oy
Kuortaneenkatu 2, 5krs
PL 620, 00031 GE - Helsinki
FINLAND
Tel: (358) 10394 2507
Fax: (358) 10394 2515

FRANCE & BENELUX

GE Lighting SARL
ZAC Paris Nord II
13, rue de la Perdrix
B.P. 50073, 95947 Roissy CDG Cedex,
FRANCE
Tel: (33) 1 48 63 68 00
Fax: (33) 1 48 63 68 08

GERMANY

GE Lighting GmbH
Eisenstr. 5
65428 Rüsselheim
GERMANY
Tel: (49) 594398 4581
Fax: (49) 594398 4582

GREECE

General Electric Medical Systems SA
156 Kyprou Av. & 91
Konstantinoupoleos Str.
164 51 Argyroupolis, Athens
GREECE
Tel: (30) 210 9690 669
Fax: (30) 210 9625 931

HONG KONG

GE International Operations Co.Inc.
8th Floor, The Lee Gardens
33 Hysan Avenue
Causeway Bay
Hong Kong
Tel: (852) 2100 6900
Fax: (852) 2376 0013

HUNGARY

GE Hungary Kft.
1044 Budapest, Váci út 77.
HUNGARY
Tel: (36) 1 399 1100
Fax: (36) 1 399 1672

INDIA, SRI LANKA

GE India Industrial Pvt Ltd.
42/1, Electronic City Phase 2
Bangalore - 560100
Karnataka
INDIA
Tel: (91) 80 41113000
Fax: (91) 80 28528366

INDONESIA

PT.GE Lighting Indonesia
Gedung BRI II, 27 th Floor
Jl.Jenderal Sudirman Kav.
44-46, Jakarta 10210
INDONESIA
Tel: (62) 21 574 5240
Fax: (62) 21 574 5241

IRELAND

GE Lighting Ltd.
280 Holly Road
Western Industrial Estate
Naas Road
Dublin 12
IRELAND
Tel: (353) 1 456 5591
Fax: (353) 1 450 4142

ITALY

GE Lighting Srl
Via Brescia 31,
36040 Torri di Quartesolo (VI)
Vicenza, ITALY
Tel: (39) 011 968 7728
Fax: (39) 011 968 7043

ISRAEL

Sun Plaza, Dereboyou Sok
No. 24/6, Maslak,
Istanbul 34398
TURKEY
Tel: (90) 212 366 28 00
Fax: (90) 212 366 28 40

JAPAN

GE Consumer Products Japan, Ltd.
12F Akasaka Park Bldg., 5-2-20
Akasaka, Minatoku,
Tokyo 107-6112
JAPAN
Tel: (81) 3 5544 6700
Fax: (81) 3 5544 6760

KAZAKHSTAN

GE International Inc. Branch in
Kazakhstan
Prime Business Center
Ul. Furmanova, 100G, Office 302
480091, Almaty, KAZAKHSTAN
Tel: (7) 3272 588 010
Fax: (7) 3272 588 011

KOREA

GE Lighting Korea
3F GE Tower, 71-3 Chungdam-Dong,
Kangnam-Gu, Seoul,
KOREA 135-100
Tel: (82) 2 6201 4300
Fax: (82) 2-6201-4343, 4344

MACEDONIA

VSD MERKUR doeel Exclusive Agent of
GE Hungary Kft.
Vasil Glavinov 7B/3
1000 Skopje
Tel: (389) 2 3244790
Fax: (389) 2 3244797

MALAYSIA

General Electric International Inc.
Level 6 & 7, 1 Sentral,
Jalan Travers,
Kuala Lumpur Sentral,
50470 Kuala Lumpur
MALAYSIA
Tel: (60) 3 2273 9788
Fax: (60) 3 2273 3473

MEXICO

GE Lighting Mexico, SA de CV
Av. Churubusco No 3900 Norte
Apartado Postal 216
64510 Monterrey, N.L. Mexico
MEXICO
Tel: (52) 8 318 5600
Fax: (52) 8 318 5693

MONTENEGRO

VSD Merkur dooel Sales
Representative of GE Hungary Kft.
Bul. Mihajla Pupina 10D/105
11070 Novi Beograd
SERBIA
Tel: (381) 11 311 9256
Fax: (389) 2 324 4797

NEW ZEALAND

GE Lighting New Zealand
8 Tangihua St
Auckland 1010
NEW ZEALAND
Tel: (64) 9 353 6706
Fax: (64) 9 353 6707

NORWAY

GE Lighting AS
Karenslyst Allé 2, 0214 Oslo
NORWAY
Tel: (47) 80 01 13 21
Fax: (47) 80 01 10 48

PERU, ECUADOR

GE Lighting Peru SA
Av. Larco 1301 Oficina 1902
Miraflores,
Lima 18
PERU
Tel: (511) 610-4347
Fax: (511) 610-4330

PHILIPPINES

GE Lighting Philippines
1873 P. Domingo Street
1207 Makati City, Metro Manila
POB 2087 MCC
PHILIPPINES
Tel: (63) 2 895 7051
Fax: (63) 2 890 8186

POLAND

GE Power Controls S.A.
ul. Leszczynska 6
43-300 Bielska Biala
POLAND
VAT no. NIP 526-10-30-824
Registration: REGON 011165913 KRS
0000073794, Sad Rejonowy dla m. st.
Warszawy, XIII Wyzczial
Gospodarzy
Krajowego Rejestru Sadowego
Initial Capital 9,365,500,00 PLN
Sales office: ul. Syrokomli 6
03-335 Warszawa
Tel: (48) 22 519 76 00
Fax: (48) 22 519 76 02

PORTUGAL

GE Lighting / Appliance España, S.A.,
Roselló i Porcel, 21 - planta 10
Edificio Meridian
08016 - Barcelona
SPAIN
Freephone in Portugal: 800.836.010
Free fax in Portugal: 800.836.007

ROMANIA, MOLDAVIA

SC VSD Merkur Lighting Group SRL
0407280 Floresti Jud. Cluj
Str. Gheorghe Doja, Bl. I3, Ap. 1
ROMANIA
Tel: (40) 726 279722
Fax: (40) 727 599235

RUSSIA

OOO GE Rus, Krasnopresnenskaya
Nab., 18, Moscow, 123317
RUSSIA
Tel: (7) 495 739 6855
Fax: (7) 495 739 6810

SAUDI ARABIA

GE International Inc.CO
5th Floor, Tatweer Towers
King Fahad Road,
PO Box: 10211
Riyadh 11433
SAUDI ARABIA
Tel: (966 1) 207-3800
Fax: (966 1) 207-3900 & 207-3901

SERBIA

VSD MERKUR dooel - Exclusive Agent of
GE Hungary Kft.
Bul. Mihajla Pupina 10 D,
lok. 105, 11070 Novi Beograd
SERBIA
Tel.: (381) 11 3119256
Fax: (381) 11 3119257

SINGAPORE, BRUNEI

GE Pacific Pte. Ltd.
240 Tanjong Pagar Road
#06-00 GE Tower
Singapore 088540
SINGAPORE
Tel: (65) 6326 3319
Fax: (65) 6326 3015

SLOVAKIA

GE Hungary Kft.
1044 Budapest
Váci út 77.
HUNGARY
Tel: (36) 1 399 1100
Fax: (36) 1 399 1672

SLOVENIA

Media Light d.o.o.
Exclusive agent of GE Hungary Kft.
Lighting and Power Protection
Cesta na Brdo 109
1000 Ljubljana
SLOVENIA
Tel: (386) 1 5304366
Fax: (386) 1 530 4361

SOUTH AFRICA

GE South Africa - Consumer and
Industrial
Unit 4, 130 Gazelle Avenue,
Corporate Park
Midrand 1685
SOUTH AFRICA
Tel: (27) 11 237 0000
Fax: (27) 11 314 7518

SPAIN

GE Lighting / Appliance España, S.A.,
Roselló i Porcel, 21 - planta 10
Edificio Meridian
08016 - Barcelona
SPAIN
Freephone in Spain: 900 984 997
Free fax in Spain: 900 993 609

SWEDEN

GE Lighting AB
Box 306, Solna Strandväg 98
171 75 STOCKHOLM
SWEDEN
Tel: (46) 08 152 422 26
Fax: (46) 08 51 99 22 14

SWITZERLAND

GE Lighting Gmbh
Eisenstr. 5
65428 Rüsselheim
GERMANY
Tel: (49) 594398 4581
Fax: (49) 594398 4582

THAILAND, CAMBODIA, LAOS

GE Lighting (Thailand) Ltd.
1126/2 Vanit Building II, 16th Floor,
Room No. 1603, New Petchburi
Road, Makkasan, Rajchthewi,
Bangkok 10400
THAILAND
Tel: (66) 2 255 8721-31
Fax: (66) 2 255 8733

TAIWAN

GE Lighting Taiwan
7FL, No 8, Sec 3, Min Sheng E. Rd,
Taipei, 104,
TAIWAN
Tel: (886) 2 21837000
Fax: (886) 2 25167356

TURKEY

Sun Plaza, Dereboyu Sokak No.
24/6, Maslak, Istanbul 34398
TURKEY
Tel.: (90) 212 366 28 00
Fax: (90) 212 366 28 40

UKRAINE

General Electric Co.
Horizont Tower
42/44 Shovkovichna str.,
8 Floor
Kiev 01004
UKRAINE
Tel: (380) 44 490 69 83
Fax: (380) 44 490 69 82

UNITED KINGDOM

GE Lighting Ltd
Houghton Centre
Salthouse Road
Brackmills
Northampton
NN4 7EX
UNITED KINGDOM
Tel: (44) 7920 711761
Fax: (44) 1543 876908

UNITED STATES OF AMERICA

GE Lighting
Nela Park, 1975 Noble Road
Cleveland, Ohio 44112
USA
Tel: (1) 216 266 2121
Fax: (1) 216 266 2780

VENEZUELA

GE Iluminacion de Venezuela
S.A. TERMAQ
Centro Banaven (Cubo Negro)
Torre A Piso 6, Avenida La Estancia,
Chuaq, Caracas,
VENEZUELA
Tel: (58) 212 902 5131
Fax: (58) 212 902 5158

VIETNAM

GE Consumer & Industrial
7fl, Saigon Centre, 65 Le Loi blv, Dist.1,
Hochiminh City,
VIETNAM
Tel: (84) 4 8251016
Fax: (84) 4 8250551

GE Lighting is constantly developing and improving its products. For this reason, all product descriptions in this catalogue are intended as a general guide, and we may change specifications from time to time in the interest of product development, without prior notification or public announcement. All descriptions in this publication present only general particulars of the goods to which they refer and shall not form part of any contract. Data in this guide has been obtained in controlled experimental conditions. However, GE Lighting cannot accept any liability arising from the reliance on such data to the extent permitted by law.

All lamp drawings are a guide, if further technical details are required please contact your nearest sales office.

General conditions of sale

GE Lighting products are supplied according to GE's General Conditions of Sale. If you require a copy of these conditions please contact your nearest GE Lighting sales office.

Prices

A price list is available from all GE Lighting sales offices.

www.gelighting.com/eu